

HERRAMIENTAS

 **Beta**

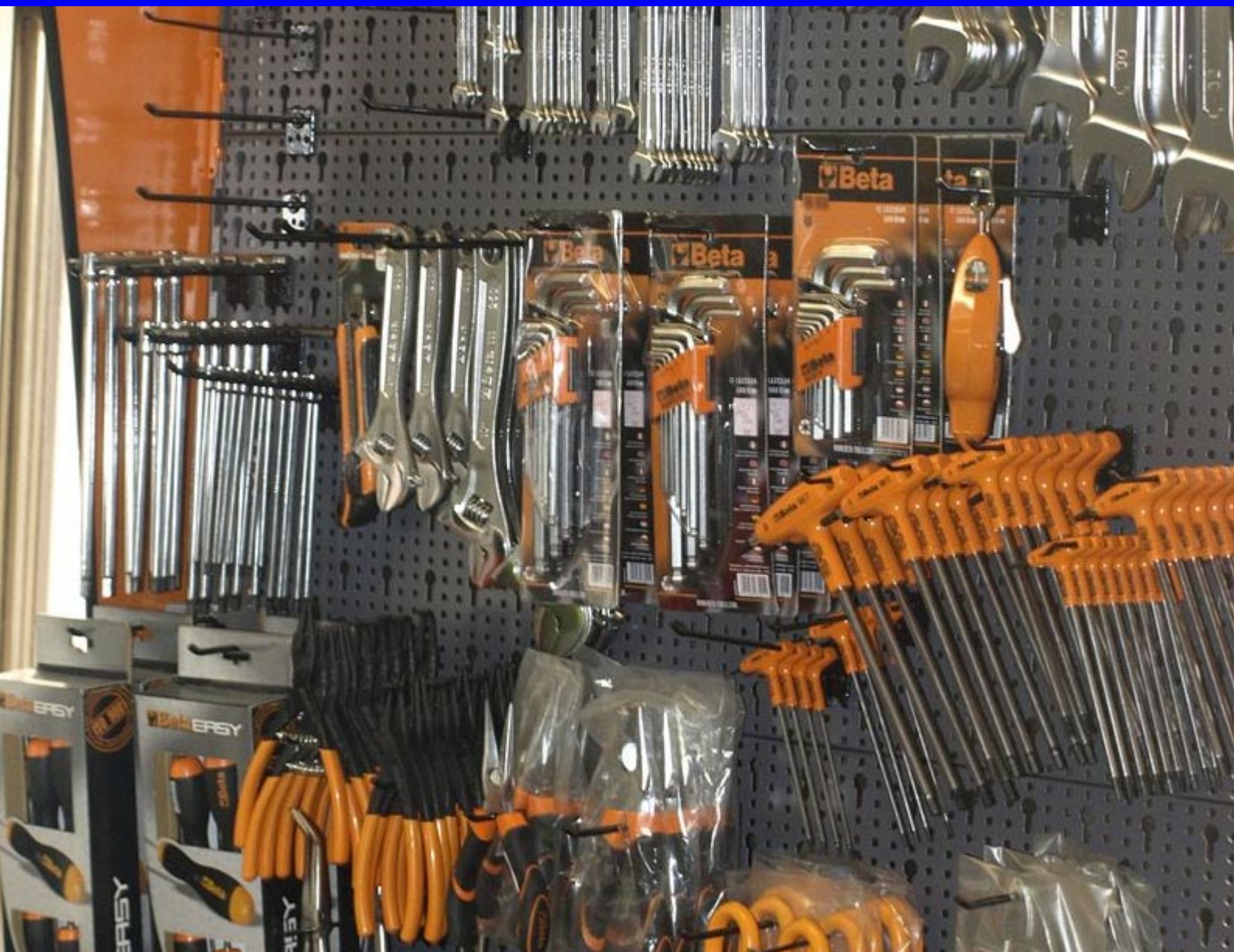

VASOS 1/4"

Vaso estándar en métrico 1/4" hexagonal

900

llaves de vaso de mano boca hexagonal

14"



Familia 0870

Referencia	art.	Ø mm	Ø mm	L mm	Ø1 mm	A mm	g
009000040	900 4	4	6,8	25	11,8	8,0	10
009000045	900 4,5	4,5	7,4	25	11,8	8,0	10
009000050	900 5	5	8,0	25	11,8	9,0	8
009000055	900 5,5	5,5	8,7	25	11,8	9,0	11
009000060	900 6	6	9,3	25	11,8	9,0	11
009000070	900 7	7	10,4	25	11,8	9,0	11,5
009000080	900 8	8	11,8	25	12,7	9,0	14
009000090	900 9	9	12,7	25	11,8	9,0	12
009000100	900 10	10	14,2	25	12,0	9,0	14
009000110	900 11	11	15,8	25	12,5	10,0	17
009000120	900 12	12	17,2	25	13,5	10,0	18
009000130	900 13	13	18,0	25	13,5	10,0	20
009000140	900 14	14	20,0	25	15,0	10,0	25

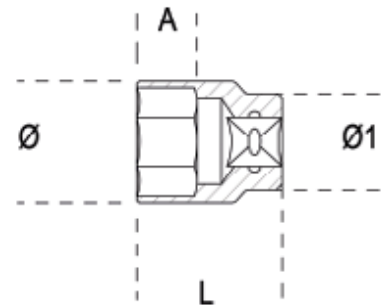

Vaso estándar en pulgadas 1/4" hexagonal

900AS

llaves de vaso de mano boca hexagonal

14"



Familia 0870

Referencia	art.	Ø	Ø mm	L mm	Ø1 mm	A mm	g
009000349	900AS 5/32	5/32	8,8	25	11,9	4,5	9
009000340	900AS 3/16	3/16	7,7	25	11,9	4,0	9
009000345	900AS 7/32	7/32	8,8	25	11,9	4,5	10
009000350	900AS 1/4	1/4	9,6	25	11,9	4,5	10
009000355	900AS 9/32	9/32	10,2	25	11,9	5,5	10
009000360	900AS 5/16	5/16	11,3	25	11,9	6,0	10,5
009000365	900AS 11/32	11/32	12,7	25	11,6	7,0	12
009000370	900AS 3/8	3/8	14,0	25	12,9	8,0	15
009000375	900AS 7/16	7/16	15,3	25	14,5	8,5	16
009000380	900AS 1/2	1/2	17,5	25	16,4	10,0	20
009000385	900AS 9/16	9/16	19,0	25	17,9	11,0	28

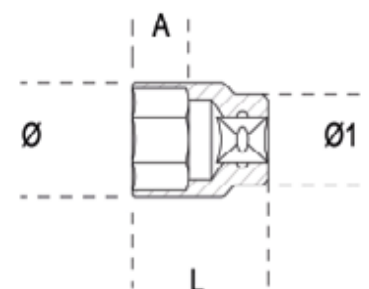

VASOS 1/4"

Vaso estándar en métrico 1/4" multicara

900MB

llaves de vaso de mano boca poligonal

14"



Familia 0870

Referencia	art.	mm	Ø mm	L mm	Ø1 mm	A mm	g
009000160	900MB 4	4	6,7	22	11,2	8,0	8
009000161	900MB 5	5	7,7	25	11,2	9,0	8
009000162	900MB 5,5	5,5	8,3	25	11,2	9,0	8
009000163	900MB 6	6	9,0	25	11,2	9,0	8
009000164	900MB 7	7	10,2	25	11,2	9,0	9
009000165	900MB 8	8	11,3	25	12,0	9,0	11
009000166	900MB 9	9	13,0	25	12,0	9,0	12
009000167	900MB 10	10	14,3	25	12,9	9,0	14
009000168	900MB 11	11	16,0	25	14,3	10,0	18
009000169	900MB 12	12	17,4	25	16,0	10,0	22
009000170	900MB 13	13	18,0	25	16,4	10,0	23
009000171	900MB 14	14	19,3	25	17,9	10,0	30

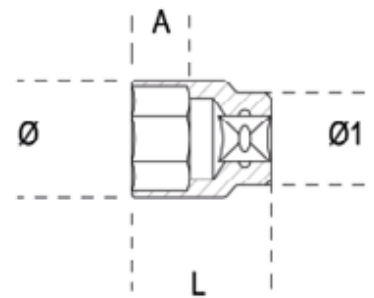

Vaso estándar en pulgadas 1/4" multicara

900AS/MB

llaves de vaso de mano boca poligonal

14"



Familia 0870

Referencia	art.	"	Ø mm	L mm	Ø1 mm	A mm	g
009000390	900AS-MB	3/16	7,7	22	10,9	4,3	8
009000391	900AS-MB	7/32	8,5	22	10,9	4,8	8
009000392	900AS-MB 1/4	1/4	9,4	22	10,9	5,0	8
009000393	900AS-MB	9/32	10,2	22	10,9	5,0	8
009000394	900AS-MB	5/16	11,3	22	11,7	6,3	10
009000395	900AS-MB	11/32	12,5	22	12,0	6,7	11
009000396	900AS-MB 3/8	3/8	13,7	22	12,9	6,7	13
009000397	900AS-MB	7/16	15,6	22	14,3	7,6	18
009000398	900AS-MB 1/2	1/2	17,2	22	16,4	8,8	21
009000399	900AS-MB	9/16	18,8	24	17,9	8,8	27

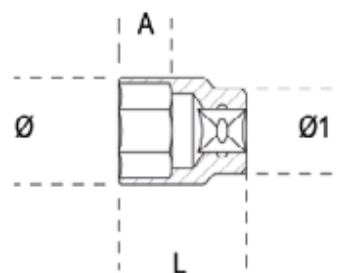

VASOS 1/4"

Vaso largo en métrico 1/4" hexagonal

900L

llaves de vaso de mano tipo largo boca hexagonal

14"



Familia 0870



Referencia	art.	mm	Ø mm	L mm	Ø1 mm	A mm	g
009000181	900L 4	4	6,5	50	12,0	5,0	23
009000182	900L 4,5	4,5	7,0	50	12,0	5,0	24
009000183	900L 5	5	7,5	50	12,0	5,0	24
009000184	900L 5,5	5,5	8,5	50	12,0	6,0	21
009000185	900L 6	6	9,5	50	12,0	7,0	25
009000186	900L 7	7	10,5	50	12,0	7,0	24
009000187	900L 8	8	12,0	50	12,0	8,0	24
009000188	900L 9	9	13,0	50	13,0	9,0	27
009000189	900L 10	10	14,0	50	14,0	10,0	36
009000190	900L 11	11	16,0	50	16,0	11,0	50
009000191	900L 12	12	17,5	50	17,5	13,0	52
009000192	900L 13	13	17,5	50	17,5	13,0	67
009000193	900L 14	14	20,0	50	20,0	13,0	81

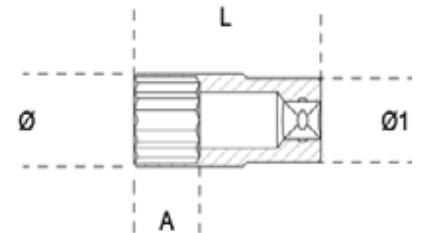

Vaso largo en pulgadas 1/4" hexagonal

900AS/L

llaves de vaso de mano tipo largo boca hexagonal

14"



Familia 0870



Referencia	art.	"	Ø mm	L mm	Ø1 mm	A mm	g
009000301	900AS-L 3/16	3/16	7,0	50	12,0	5,0	20
009000303	900AS-L 7/32	7/32	8,5	50	12,0	6,0	24
009000305	900AS-L 1/4	1/4	9,8	50	12,0	7,0	20
009000307	900AS-L 9/32	9/32	10,5	50	12,0	7,0	25
009000309	900AS-L 5/16	5/16	12,0	50	12,0	8,0	29
009000311	900AS-L 11/32	11/32	13,0	50	13,0	9,0	28
009000313	900AS-L 3/8	3/8	14,0	50	14,0	10,0	37
009000315	900AS-L 7/16	7/16	16,0	50	16,0	11,0	49
009000317	900AS-L 1/2	1/2	17,5	50	17,5	13,0	60
009000319	900AS-L 9/16	9/16	20,0	50	20,0	13,0	74

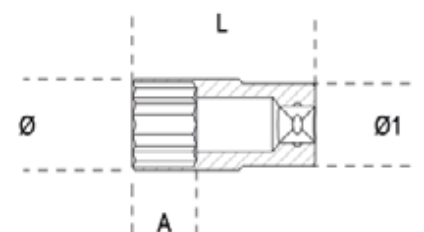

VASOS 1/4"

Vaso largo en métrico 1/4" multicara

900MB/L

llaves de vaso de mano tipo largo boca poligonal

14"



Familia 0870



Referencia	art.	mm	Ø mm	L mm	Ø1 mm	A mm	g
009000211	900MB-L 5	5	8,0	50	12,0	3,7	21
009000212	900MB-L 6	6	9,3	50	12,0	5,2	24
009000213	900MB-L 7	7	10,9	50	12,0	6,0	26
009000214	900MB-L 8	8	11,6	50	12,0	7,5	26
009000215	900MB-L 9	9	13,0	50	12,0	7,5	28
009000216	900MB-L 10	10	14,3	50	12,8	9,0	34
009000217	900MB-L 11	11	16,0	50	14,2	10,5	43
009000218	900MB-L 12	12	17,4	50	15,5	12,0	50
009000219	900MB-L 13	13	18,0	50	16,2	12,0	50
009000220	900MB-L 14	14	19,0	50	17,1	15,0	54

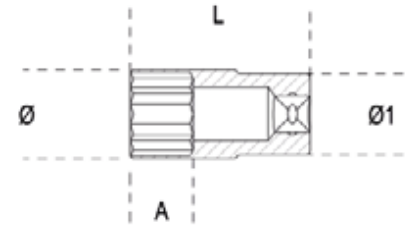

Vaso largo en pulgadas 1/4" multicara

900AS/MBL

llaves de vaso de mano tipo largo boca poligonal

14"



Familia 0870



Referencia	art.	"	Ø mm	L mm	Ø1 mm	A mm	g
009000325	900AS-MBL	5/32	6,8	50	12,0	3,0	21
009000326	900AS-MBL	3/16	8,0	50	12,0	3,7	21
009000327	900AS-MBL	7/32	8,5	50	12,0	4,5	21
009000328	900AS-MBL	1/4	9,8	50	12,0	5,2	25
009000329	900AS-MBL	9/32	10,9	50	12,0	6,0	26
009000330	900AS-MBL	5/16	11,6	50	12,0	7,5	26
009000331	900AS-MBL	11/32	13,0	50	12,0	7,5	28
009000332	900AS-MBL	3/8	14,3	50	12,8	9,0	35
009000333	900AS-MBL	7/16	16,0	50	14,2	10,5	43
009000334	900AS-MBL	1/2	18,0	50	16,2	12,0	49
009000335	900AS-MBL	9/16	19,0	50	17,1	15,0	53

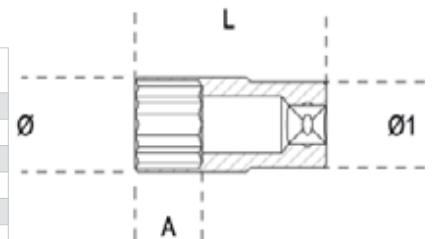

VASOS 1/4"

Vaso estándar para tornillos macho Torx 1/4

900FTX

llaves de vasos de mano para tornillos con perfil Torx®

14"



Familia 0870



Referencia	art.	⊙	Ø mm	L mm	Ø1 mm	A mm	g
009000404	900FTX 4	E4	5,4	22	11,2	4,5	7
009000405	900FTX 5	E5	6,7	22	11,2	4,5	7,5
009000406	900FTX 6	E6	7,7	22	11,2	5,0	8
009000407	900FTX 7	E7	8,3	22	11,2	5,8	8,5
009000408	900FTX 8	E8	9,6	22	11,2	6,6	9
009000410	900FTX 10	E10	11,3	22	12,0	7,4	11
009000411	900FTX 11	E11	12,1	22	12,5	8,2	13
009000412	900FTX 12	E12	12,9	23	12,9	9,0	15
009000414	900FTX 14	E14	14,0	25	14,0	10,0	18

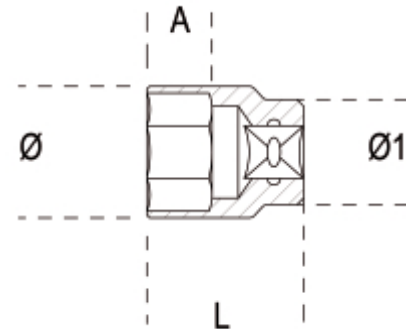

Vaso con punta ranurada 1/4"

900LP

vasos destornilladores para tornillos ranurados

14"



Familia 0870



Referencia	art.	SxA mm	Ø mm	L mm	L1 mm	g
009000605	900LP 0,8X4	0,8x4	12	28	9	9,5
009000610	900LP 1X5,5	1x5,5	12	28	9	9,5
009000615	900LP 1,2X6,5	1,2x6,5	12	28	9	10,5
009000620	900LP 1,2X8	1,2x8	13	28	8	11,5
009000625	900LP 1,6X10	1,6x10	14	28	8	13

VASOS 1/4"

Vaso con punta Phillips 1/4"

900PH

vasos destornilladores para tornillos con huella de cruz Phillips®

1/4"



Familia 0870



Referencia	art.	PH	Ø mm	L mm	L1 mm	g
009000701	900PH 1	1	12	28	12	9
009000702	900PH 2	2	12	28	12	10
009000703	900PH 3	3	12	28	12	12
009000704	900PH 4	4	13	28	11	13

Vaso con punta hexagonal 1/4"

900ME

vasos macho hexagonales

1/4"



Familia 0870



Referencia	art.	mm	Ø mm	L mm	L1 mm	g
009000502	900ME 2,5	2,5	12	25	4,5	9,0
009000503	900ME 3	3	12	25	5,0	9,5
009000504	900ME 4	4	12	25	5,6	9,9
009000505	900ME 5	5	12	25	6,3	10
009000506	900ME 6	6	12	25	7,6	11
009000507	900ME 7	7	13	25	7,2	15
009000508	900ME 8	8	13	25	8,0	14
009000510	900ME 10	10	13	25	8,7	16

VASOS 1/4"

Vaso con punta Torx 1/4"

900TX

vasos macho para tornillos con huella Torx®

14"



Familia 0870



Referencia	art.	Ø				
009000719	900TX 08	T8	12	28	12	7
009000720	900TX 09	T9	12	28	12	7,5
009000721	900TX 10	T10	12	28	12	8,1
009000722	900TX 15	T15	12	28	12	8
009000723	900TX 20	T20	12	28	12	8
009000724	900TX 25	T25	12	28	12	8
009000725	900TX 27	T27	12	28	12	8,4
009000726	900TX 30	T30	12	28	12	8
009000727	900TX 40	T40	12	28	12	9

Carraca cabeza redonda 1/4" 48d

900/55

carraca reversible con cuadrado macho 1/4", 48 dientes

14"



Familia 0870



Referencia	art.	L mm	Ø mm	A mm	■	g
009000870	900/55	125	25	18	1/4	90



• despiece

Referencia	art.
009000871	900/R55



VASOS 1/4"

Carraca estándar metal 1/4" 48d

900M/55

carraca reversible con cuadrado macho 1/4" con mango de metal

14"

Familia 0870



Referencia	art.	L mm	Ø mm	A mm	■	g
009000905	900M/55	110	22	18	1/4	75

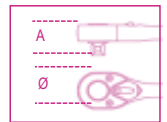

• despiece

Referencia	art.
009000888	900M/R55



Carraca con cabeza giratoria 1/4" 52d

900/58

carraca reversible con mango giratorio con cuadrado macho 1/4" mecanismo de 52 dientes

- Sistema de utilización con mango giratorio
- Pulsador para soltar el vaso
- Sistema de inversión de arandela en la cabeza de la carraca
- Mango bimaterial



Referencia	art.	L mm	Ø mm	A mm	g
009000884	900/58	126	28	28,5	155

VASOS 1/4"

Extensión estándar 1/4" 50-350mm

900/...

alargaderas con cuadrado macho y hembra 1/4"

1/4"

Familia 0870

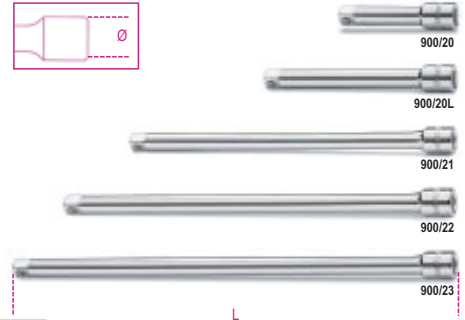

Referencia	art.	L mm	Ø mm	□	■	g
009000818	900/20	50	11,5	1/4	1/4	20
009000819	900/20L	100	11,5	1/4	1/4	44
009000822	900/21	150	11,5	1/4	1/4	64
009000823	900/22	250	11,5	1/4	1/4	108
009000824	900/23	350	11,5	1/4	1/4	147

Extensión angular 1/4" 50-100mm

900AN

alargaderas con cuadrado macho y hembra 1/4" angulares

1/4"

Familia 0870

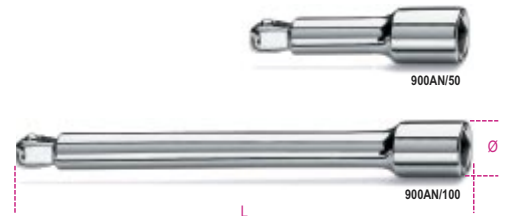

Referencia	art.	L mm	Ø mm	□	■	g
009000825	900AN/50	50	11,5	1/4	1/4	22
009000826	900AN/100	100	11,5	1/4	1/4	44



VASOS 1/4"

Empuñadura articulada 1/4"

900/35A

mango articulado macho 1/4"

14"

Familia 0870



Referencia	art.	L mm	L1 mm	■	g
009000840	900/35A	148	84	1/4	72

Empuñadura corredera 1/4"

900/42

mango corredizo macho 1/4"

14"

Familia 0870

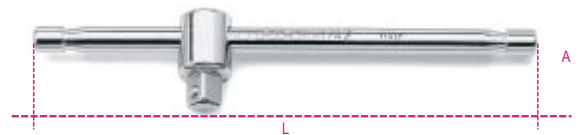

Referencia	art.	L mm	A mm	■	g
009000854	900/42	115	22	1/4	37

VASOS 1/4"

Adaptador porta puntas 1/4"

895

vasos porta puntas para puntas 861 - 862 - 866

Familia 0870

Referencia	art.	○	□	L mm	∅ mm	g
008950000	895/1	1/4	1/4	25,4	12	10



Cuadrado aumentador 1/4" x 3/8"

900/16

adaptador con cuadrado hembra 1/4" y macho 3/8"

14"

Familia 0870

Referencia	art.	L mm	∅ mm	□	■	g
009000814	900/16	28	13,0	1/4	3/8	16



VASOS 1/4"

Destornillador porta puntas 1/4"

851SR

portapuntas de desenganche rápido con mango



Familia 0870



Referencia	art.	L mm	L1 mm	g
008510001	851SR	230	110	124,5

Destornillador con cuadrado 1/4"

900BG/30

mango recto macho 1/4"



Familia 0870

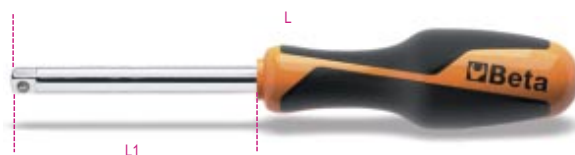

Referencia	art.	L mm	L1 mm	gr
009000834	900BG/30	176	68	81

VASOS 1/4"

Articulación Universal 1/4"

900/25

articulación universal 1/4"

1/4"

Familia 0870



Referencia	art.	L mm	Ø mm	□	■	g
009000830	900/25	41	12,5	1/4	1/4	22

VASOS 3/8"

Vaso estándar en métrico 3/8" hexagonal

910A

llaves de vaso de mano boca hexagonal



Familia 0870

Referencia	art.	mm	Ø mm	L mm	Ø1 mm	A mm	g
009100006	910A 6	6	9,5	28	16,7	4,0	21
009100007	910A 7	7	10,7	28	16,7	4,0	21
009100008	910A 8	8	12,1	28	16,7	5,0	24
009100009	910A 9	9	13,2	28	16,7	5,0	23
009100010	910A 10	10	14,6	29	16,7	6,0	26
009100011	910A 11	11	15,8	29	16,7	7,0	26
009100012	910A 12	12	17,2	30	17,7	8,0	32
009100013	910A 13	13	18,4	31	17,0	8,0	34
009100014	910A 14	14	19,7	32	17,5	10,0	37
009100015	910A 15	15	20,9	32	18,0	10,0	44
009100016	910A 16	16	22,2	33	18,5	10,0	51
009100017	910A 17	17	23,2	33	19,0	10,0	55
009100018	910A 18	18	24,7	34	20,0	12,0	65
009100019	910A 19	19	25,8	35	21,0	12,0	73
009100020	910A 20	20	27,2	35	22,0	12,0	74
009100021	910A 21	21	28,2	36	23,0	14,0	82
009100022	910A 22	22	29,7	37	24,0	14,0	100

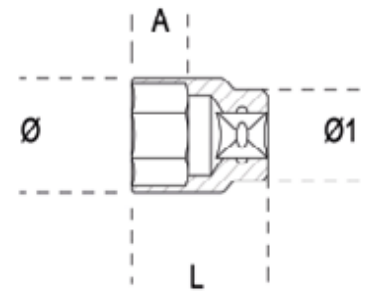

Vaso estándar en pulgadas 3/8" hexagonal

910A/AS

llaves de vaso de mano boca hexagonal



Familia 0870

Referencia	art.	"	Ø mm	L mm	Ø1 mm	A mm	g
009100276	910A-AS 1/4	1/4	10,3	26	17,3	6,0	22,2
009100278	910A-AS 5/16	5/16	11,9	26	17,3	6,9	23
009100279	910A-AS 11/32	11/32	13,3	26	17,3	7,5	23,6
009100280	910A-AS 3/8	3/8	13,9	26	17,3	8,0	23,6
009100281	910A-AS 7/16	7/16	15,8	26	17,3	9,3	24
009100283	910A-AS 1/2	1/2	17,9	26	17,3	9,4	25,8
009100284	910A-AS 9/16	9/16	19,5	27	18,5	11,0	30,4
009100285	910A-AS 19/32	19/32	20,6	27	19,5	11,5	
009100286	910A-AS 5/8	5/8	21,9	28	20,0	12,0	40,2
009100287	910A-AS 11/16	11/16	24,6	30	22,5	13,0	59,4
009100289	910A-AS 3/4	3/4	25,9	30	23,5	13,5	63,4
009100291	910A-AS 13/16	13/16	27,9	32	26,0	14,5	80,8
009100292	910A-AS 7/8	7/8	29,6	32	26,5	15,0	86,2

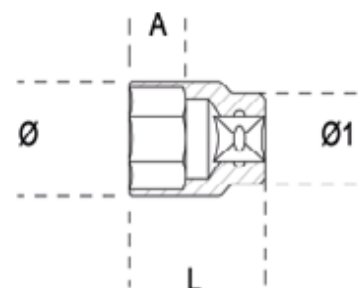

VASOS 3/8"

Vaso estándar en métrico 3/8" multicara

910B

llaves de vaso de mano boca poligonal



Familia 0870

Referencia	art.	mm	Ø mm	L mm	Ø1 mm	A mm	g
009100106	910B 6	6	9,5	28	16,7	4,0	22
009100107	910B 7	7	10,7	28	16,7	4,0	23
009100108	910B 8	8	12,1	28	16,7	5,0	21,8
009100109	910B 9	9	13,2	28	16,7	5,0	24
009100110	910B 10	10	14,6	29	16,7	6,0	26
009100111	910B 11	11	15,8	29	16,7	7,0	26,2
009100112	910B 12	12	17,2	30	17,7	8,0	31,8
009100113	910B 13	13	18,4	31	17,0	8,0	32,8
009100114	910B 14	14	19,7	32	17,5	10,0	38,8
009100115	910B 15	15	20,9	32	18,0	10,0	42,6
009100116	910B 16	16	22,2	33	18,5	10,0	53
009100117	910B 17	17	23,2	33	19,0	10,0	53,6
009100118	910B 18	18	24,7	34	20,0	12,0	58,4
009100119	910B 19	19	25,8	35	21,0	12,0	66,6
009100120	910B 20	20	27,2	35	22,0	12,0	77,4
009100121	910B 21	21	28,2	36	23,0	14,0	80,2
009100122	910B 22	22	29,7	37	24,0	14,0	96,4

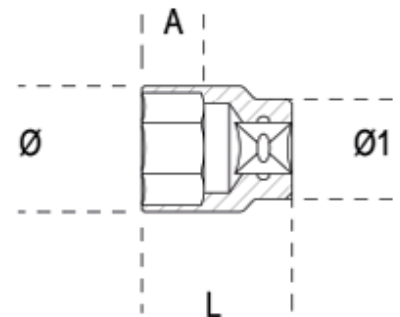

Vaso estándar en pulgadas 3/8" multicara

910AS

llaves de vaso de mano boca poligonal



Familia 0870

Referencia	art.	"	Ø mm	L mm	Ø1 mm	A mm	g
009100201	910AS 1/4	1/4	9,5	28	16,7	4,0	23
009100202	910AS 5/16	5/16	12,1	28	16,7	5,0	24
009100203	910AS 11/32	11/32	13,2	28	16,7	5,0	25
009100204	910AS 3/8	3/8	14,6	29	16,7	6,0	27
009100205	910AS 7/16	7/16	15,8	29	16,7	7,0	25,6
009100206	910AS 1/2	1/2	18,4	31	17,0	8,0	33
009100207	910AS 9/16	9/16	19,7	32	17,5	10,0	37
009100208	910AS 19/32	19/32	20,9	32	18,0	10,0	41
009100209	910AS 5/8	5/8	22,2	33	18,5	10,0	46,3
009100210	910AS 11/16	11/16	24,7	34	20,0	12,0	64
009100211	910AS 3/4	3/4	25,8	35	21,0	12,0	70
009100212	910AS 13/16	13/16	28,2	36	23,0	14,0	82,6
009100213	910AS 7/8	7/8	29,7	37	24,0	14,0	90,8

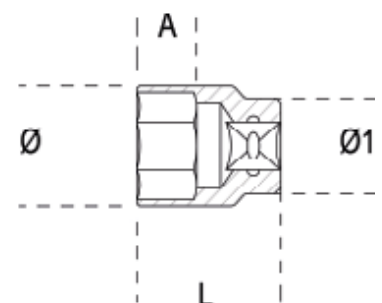

VASOS 3/8"

Vaso largo en métrico 3/8" hexagonal

910AL

llaves de vaso de mano tipo largo boca hexagonal



Familia 0870

Referencia	art.	mm	Ø mm	L mm	Ø1 mm	A mm	g
009100158	910AL 8	8	12,0	55	17	7	33
009100159	910AL 9	9	13,0	55	17	7	37
009100160	910AL 10	10	14,5	55	17	9	43
009100161	910AL 11	11	16,0	55	17	10	49
009100162	910AL 12	12	17,0	55	17	12	50
009100163	910AL 13	13	18,0	55	17	12	52
009100164	910AL 14	14	20,0	55	18	15	68
009100165	910AL 15	15	21,0	55	20	15	75
009100166	910AL 16	16	22,0	55	20	15	77
009100167	910AL 17	17	23,5	55	22	15	90
009100168	910AL 18	18	24,5	55	23	18	100
009100169	910AL 19	19	25,0	55	24	18	100
009100171	910AL 21	21	27,0	65	26	18	133
009100172	910AL 22	22	29,0	65	28	21	150

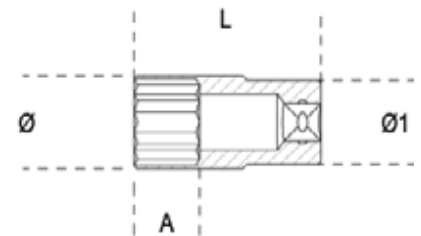

Vaso largo en métrico 3/8" multicara

910BL

llaves de vaso de mano tipo largo boca poligonal



Familia 0870

Referencia	art.	mm	Ø mm	L mm	Ø1 mm	A mm	g
009100308	910BL 8	8	12,0	55	17	7	50
009100309	910BL 9	9	13,0	55	17	7	47,8
009100310	910BL 10	10	14,5	55	17	9	51
009100311	910BL 11	11	16,0	55	17	10	54,3
009100312	910BL 12	12	17,0	55	17	12	55
009100313	910BL 13	13	18,0	55	17	12	54,8
009100314	910BL 14	14	20,0	55	18	15	66,5
009100315	910BL 15	15	21,0	55	20	15	77
009100316	910BL 16	16	22,0	55	20	15	76
009100317	910BL 17	17	23,5	55	22	15	93
009100318	910BL 18	18	24,5	55	23	18	99,9
009100319	910BL 19	19	25,0	55	24	18	98
009100321	910BL 21	21	27,0	65	26	18	128
009100322	910BL 22	22	29,0	65	28	21	156

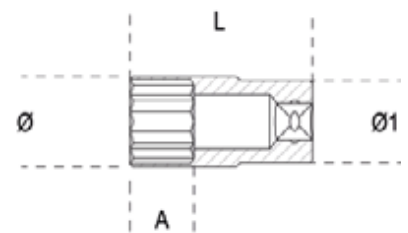

VASOS 3/8"

Vaso largo en pulgadas 3/8" multicara

910AS/L

llaves de vaso de mano tipo largo boca poligonal



Familia 0870



Referencia	art.	"	Ø mm	L mm	Ø1 mm	A mm	g
009100350	910AS-L 1/4	1/4	10	55	17	7,0	44
009100351	910AS-L 5/16	5/16	12	55	17	7,0	49
009100352	910AS-L 3/8	3/8	14	55	17	9,0	51
009100353	910AS-L 7/16	7/16	16	55	17	10,0	56
009100354	910AS-L 1/2	1/2	18	55	17	12,0	55
009100355	910AS-L 9/16	9/16	20	55	18	15,0	65
009100356	910AS-L 19/32	19/32	21	55	20	15,0	77
009100357	910AS-L 5/8	5/8	22	55	20	15,0	75,9
009100359	910AS-L 11/16	11/16	23	55	22	15,0	90
009100360	910AS-L 3/4	3/4	25	55	24	18,0	97
009100362	910AS-L 13/16	13/16	27	65	26	18,0	131
009100363	910AS-L 7/8	7/8	29	65	28	21,0	157

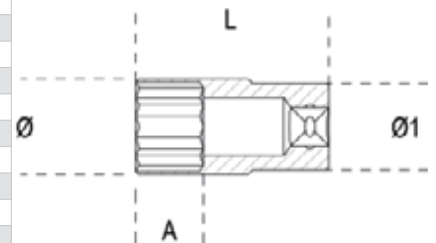

Vaso estándar para tornillos macho torx 3/8

910FTX

llaves de vasos de mano largos para tornillos con perfil Torx®



Familia 0870



Referencia	art.	°	Ø mm	L mm	Ø1 mm	A mm	g
009100404	910FTX 4	E4	6,2	26	17,3	3,2	18,8
009100405	910FTX 5	E5	7,0	26	17,3	3,2	20
009100406	910FTX 6	E6	8,3	26	17,3	4,0	21
009100407	910FTX 7	E7	8,9	26	17,3	4,8	22
009100408	910FTX 8	E8	9,9	26	17,3	5,6	22
009100410	910FTX 10	E10	12,0	26	17,3	6,4	23
009100412	910FTX 12	E12	14,5	26	17,3	8,0	25
009100414	910FTX 14	E14	15,8	26	17,3	8,8	25
009100416	910FTX 16	E16	18,0	26	17,3	9,6	26

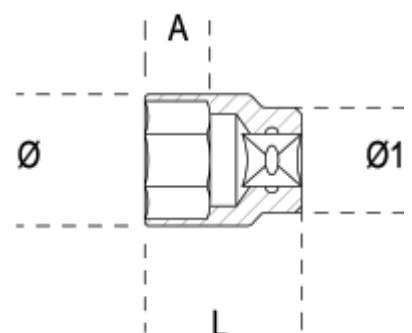

VASOS 3/8"

Vaso largo para tornillos macho Torx 3/8

910FTX/L

llaves de vasos de mano largos para tornillo con perfil Torx®

3/8"



Familia 0870



Referencia	art.	⊙	∅ mm	L mm	∅1 mm	A mm	g
009100440	910FTX-L 4	E4	6,2	55	17,3	3,5	28
009100441	910FTX-L 5	E5	7,0	55	17,3	3,5	30,6
009100442	910FTX-L 6	E6	8,3	55	17,3	4	33
009100443	910FTX-L 7	E7	8,9	55	17,3	4,8	36,6
009100444	910FTX-L 8	E8	9,9	55	17,3	5,6	40
009100445	910FTX-L 10	E10	12,0	55	17,3	6,4	44,6

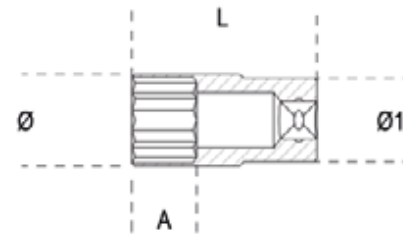

Vaso articulado métrico 3/8 multicara

910B/SN

llaves de vaso de mano articuladas boca poligonal

3/8"



Familia 0870



Referencia	art.	mm	∅ mm	L mm	∅1 mm	A mm	g
009100230	910B/SN 10	10	14,5	48,5	19	8,8	60
009100231	910B/SN 11	11	15,8	49,5	19	9,8	61
009100232	910B/SN 12	12	17,0	50,0	19	10,3	62
009100233	910B/SN 13	13	18,3	51,0	19	11,3	64
009100234	910B/SN 14	14	19,5	51,0	19	11,3	63
009100235	910B/SN 15	15	20,8	53,5	19	12,8	69
009100236	910B/SN 16	16	22,0	53,5	19	12,8	71
009100237	910B/SN 17	17	23,3	54,5	19	13,8	74
009100238	910B/SN 18	18	24,5	54,5	19	13,8	77
009100239	910B/SN 19	19	25,8	56,5	19	13,8	83

VASOS 3/8"

Vaso articulado pulgadas 3/8 multicara

910AS/SN

llaves de vaso de mano articuladas boca poligonal

3/8"



Familia 0870



Referencia	art.	"	Ø mm	L mm	Ø1 mm	A mm	g
009100260	910AS-SN 3/8	3/8	14,0	48,0	19	8,0	58
009100261	910AS-SN	7/16	15,8	51,0	19	9,8	61
009100262	910AS-SN 1/2	1/2	18,3	51,0	19	11,3	64
009100263	910AS-SN	9/16	19,5	51,0	19	11,3	62
009100264	910AS-SN 5/8	5/8	22,0	53,5	19	12,8	72
009100265	910AS-SN	11/16	24,5	54,5	19	13,8	76
009100266	910AS-SN 3/4	3/4	25,8	56,5	19	15,8	83

Vaso con punta ranurada 3/8"

910LP

vasos destornilladores para tornillos ranurados

3/8"



Familia 0870

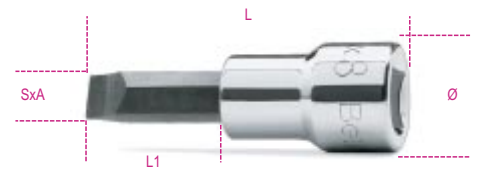

Referencia	art.	SxA mm	Ø mm	L mm	L1 mm	g
009100452	910LP 1X5,5	1x5,5	18,5	54	24	42,9
009100453	910LP 1,2X6,5	1,2x6,5	18,5	54	24	45,4
009100454	910LP 1,2X8	1,2x8	18,5	54	24	47,6
009100456	910LP 1,6X9	1,6x9	18,5	54	24	47

VASOS 3/8"

Vaso con punta Phillips 3/8"

910PH

vasos destornilladores para tornillos con huella de cruz Phillips®



Familia 0870

Referencia	art.	PH	Ø mm	L mm	L1 mm	g
009100471	910PH 1	1	18,5	48	18	44,9
009100472	910PH 2	2	18,5	48	18	44,4
009100473	910PH 3	3	18,5	48	18	44,5
009100474	910PH 4	4	18,5	48	18	52,2



Vaso con punta hexagonal 3/8"

910PE

vasos macho hexagonales



Familia 0870

Referencia	art.	mm	Ø mm	L mm	L1 mm	g
009100490	910PE 3	3	18,5	50	20	40,2
009100492	910PE 4	4	18,5	50	20	40,8
009100494	910PE 5	5	18,5	50	20	41,7
009100496	910PE 6	6	18,5	50	20	45
009100497	910PE 7	7	18,5	50	20	47
009100498	910PE 8	8	18,5	50	20	44,8
009100500	910PE 10	10	18,5	50	20	59



VASOS 3/8"

Vaso con punta Torx 3/8"

910TX

vasos macho para tornillos con huella Torx®



Familia 0870

Referencia	art.	⊙	∅ mm	L mm	L1 mm	g
009100519	910TX 15	T15	18,5	50	20	40,8
009100520	910TX 20	T20	18,5	50	20	40,5
009100521	910TX 25	T25	18,5	50	20	41,5
009100522	910TX 27	T27	18,5	50	20	41,5
009100523	910TX 30	T30	18,5	50	20	42
009100524	910TX 40	T40	18,5	50	20	43,2



Vaso con punta huella 5 puntas inviolable 3/8"

910PT

llaves de vaso de destornillador para tornillos con huella en estrella de cinco puntas inviolable



Familia 0870

Referencia	art.	⊙	∅ mm	L mm	L1 mm	g
009100540	910PT 40	PT40	20	50	20	39,3
009100545	910PT 45	PT45	20	50	20	40,6
009100550	910PT 50	PT50	20	50	20	55,6

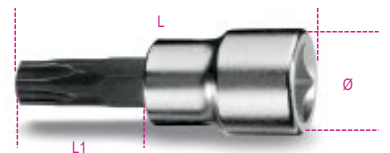

VASOS 3/8"

Carraca Cabeza redonda 3/8" 48d

910/55Q

carraca reversible con cuadrado macho 3/8", 48 dientes



Familia 0870



Referencia	art.	L mm	Ø mm	A mm	■	g
009100885	910/55Q	200	30	33	3/8	246,7

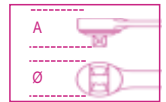

• despiece

Referencia	art.
009100877	910/R55Q



Carraca cabeza redonda 3/8" 72d

910/55

carraca reversible con cuadrado macho 3/8", 72 dientes



Familia 0870



Referencia	art.	L mm	Ø mm	A mm	■	g
009100882	910/55	200	30	33	3/8	238,8



• despiece

Referencia	art.
009100879	910/R55



VASOS 3/8"

Carraca estándar metal 3/8" 48d

910M/55

carraca reversible con cuadrado macho 3/8" con mango de metal

3/8"

Familia 0870

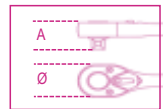

Referencia	art.	L mm	Ø mm	A mm	■	g
009100875	910M/55	178	30	26	3/8	245

• despiece

Referencia	art.
009100888	910M/R55



Carraca con cabeza giratoria 3/8" 52d

910/58

carraca reversible con mango giratorio con cuadrado macho 3/8", mecanismo de 52 dientes

3/8"

Familia 0870

- Sistema de utilización con mango giratorio
- Pulsador para soltar el vaso
- Sistema de inversión de arandela en la cabeza de la carraca
- Mango bimaternal

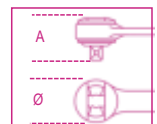

Referencia	art.	L mm	Ø mm	A mm	g
009100884	910/58	222	37	38,5	417

VASOS 3/8"

Extensión estándar 3/8" 75-250mm

910/...

alargaderas con cuadrado macho y hembra 3/8"

3/8"

Familia 0870

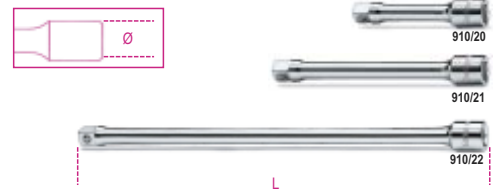

Referencia	art.	L mm				
009100820	910/20	75	17	3/8	3/8	80
009100822	910/21	125	17	3/8	3/8	90
009100826	910/22	250	17	3/8	3/8	173,8

Extensión angular 3/8" 75-250mm

910AN

alargaderas con cuadrado macho y hembra 3/8" angulares

3/8"

Familia 0870

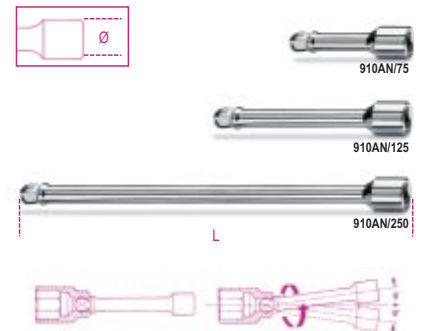

Referencia	art.	L mm	Ø mm	□	■	g
009100827	910AN/75	75	17	3/8	3/8	57
009100828	910AN/125	125	17	3/8	3/8	93
009100829	910AN/250	250	17	3/8	3/8	165

VASOS 3/8"

Empuñadura articulada 3/8"

910/36A

mango articulado macho 3/8"

3/8"

Familia 0870



Referencia	art.	L mm	L1 mm	■	g
009100845	910/36A	255	154	3/8	210

Empuñadura corredera 3/8"

910/42

mango corredizo macho 3/8"

3/8"

Familia 0870



Referencia	art.	L mm	A mm	■	g
009100854	910/42	210	30,5	3/8	160,2

VASOS 3/8"

Adaptador porta puntas 3/8"

895

vasos portapuntas para puntas 861 - 862

Familia 0870

Referencia	art.	○	□	L mm	∅ mm	g
008950001	895/3	1/4	3/8	29	16,8	30,8



Adaptador porta puntas 3/8"

867

vasos portapuntas para puntas 867 (10 mm)

Familia 0870

Referencia	art.	○	□	L mm	∅ mm	g
008670600	867/1	10	3/8	38	17	28,8

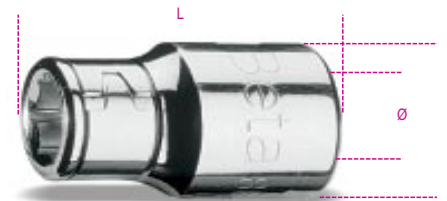

Cuadrado aumentador 3/8" x 1/2"

910/16

adaptador con cuadrado hembra 3/8" y macho 1/2"

3/8"

Familia 0870

Referencia	art.	L mm	∅ mm	□	■	g
009100814	910/16	32	18,0	3/8	1/2	39



VASOS 3/8"

Cuadrado reductor 3/8" x 1/4"

910/15

adaptador con cuadrado hembra 3/8" y macho 1/4"



Familia 0870

¡Es absolutamente necesario aplicar la carga de torsión de manera adecuada y progresiva para evitar roturas o daños accidentales!



Referencia	art.	L mm	Ø mm	□	■	g
009100810	910/15	30	17,0	3/8	1/4	25,8

Articulación Universal 3/8"

910/25

articulación universal 3/8"



Familia 0870

Referencia	art.	L mm	Ø mm	□	■	g
009100830	910/25	54,6	19	3/8	3/8	70



VASOS 1/2"

Vaso estándar en métrico 1/2" hexagonal

920A

llaves de vaso de mano boca hexagonal

12"



Familia 0870

Referencia	art.	Ø mm	Ø mm	L mm	Ø1 mm	A mm	g
009200008	920A 8	8	12,4	38	21,7	5,0	48
009200009	920A 9	9	13,5	38	21,7	5,0	48
009200010	920A 10	10	14,9	38	21,7	6,0	49
009200011	920A 11	11	16,1	38	21,7	7,0	49,2
009200012	920A 12	12	17,5	38	21,7	8,0	54
009200013	920A 13	13	18,7	38	21,7	8,0	55
009200014	920A 14	14	20,1	38	21,7	10,0	57
009200015	920A 15	15	21,5	38	22,5	10,0	62
009200016	920A 16	16	22,7	38	23,7	10,0	71,2
009200017	920A 17	17	24,1	38	23,1	10,0	73
009200018	920A 18	18	25,3	39	24,0	12,0	78
009200019	920A 19	19	26,6	39	24,0	12,0	83,8
009200020	920A 20	20	27,8	40	25,0	12,0	98
009200021	920A 21	21	28,8	40	25,0	14,0	98,8
009200022	920A 22	22	29,9	41	26,0	14,0	110
009200023	920A 23	23	30,8	42	26,0	14,0	113,7
009200024	920A 24	24	32,2	43	27,0	16,0	144
009200025	920A 25	25	33,2	44	27,0	16,0	154
009200026	920A 26	26	34,7	45	28,0	16,0	167
009200027	920A 27	27	36,2	46	29,0	18,0	174
009200028	920A 28	28	37,2	47	30,0	18,0	209
009200029	920A 29	29	38,6	48	31,0	18,0	208
009200030	920A 30	30	40,2	48	32,0	20,0	240
009200032	920A 32	32	42,3	49	34,0	22,0	265

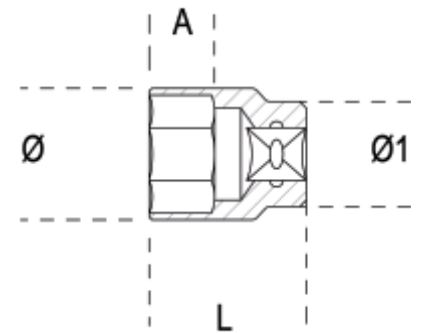

VASOS 1/2"

Vaso estándar en pulgadas 1/2" hexagonal

920A/AS

llaves de vaso de mano boca hexagonal

12"



Familia 0870

Referencia	art.	"	Ø mm	L mm	Ø1 mm	A mm	g
009200270	920A-AS 3/8	3/8	14,6	37	21	8	44,4
009200272	920A-AS 7/16	7/16	16,5	37	21	8,5	46,4
009200273	920A-AS 1/2	1/2	19,0	37	22	9,5	55,6
009200274	920A-AS 9/16	9/16	20,3	37	22	10	55,2
009200275	920A-AS 19/32	19/32	21,0	37	22	10,5	57
009200276	920A-AS 5/8	5/8	22,8	37	22	11	60,2
009200277	920A-AS 11/16	11/16	25,0	37	24	12	75,6
009200279	920A-AS 3/4	3/4	26,5	38	25	13	82
009200280	920A-AS 25/32	25/32	28,0	38	26	14	90
009200281	920A-AS 13/16	13/16	29,0	38	27	14,5	102,6
009200282	920A-AS 7/8	7/8	30,0	40	28	15	113,6
009200284	920A-AS 15/16	15/16	32,8	42	30	16	146,8
009200285	920A-AS 1	1	35,0	42	32	18	162,6
009200287	920A-AS	1.1/16	36,5	43	33	18,5	181,4
009200289	920A-AS 1.1/8	1.1/8	39,0	43	35	19,5	211,2
009200290	920A-AS	1.3/16	41,0	46	36	20	225
009200292	920A-AS 1.1/4	1.1/4	42,8	46	38	22	259,6

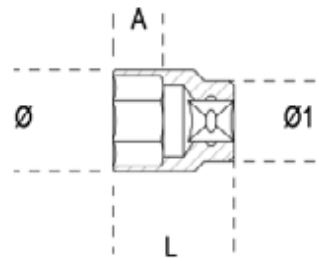

Vaso estándar en métrico 1/2" multicara

920B

llaves de vaso de mano boca poligonal

12"



Familia 0870

Referencia	art.	mm	Ø mm	L mm	Ø1 mm	A mm	g
009200108	920B 8	8	12,4	38	21,7	5,0	47
009200109	920B 9	9	13,5	38	21,7	5,0	48,6
009200110	920B 10	10	14,9	38	21,7	6,0	46,6
009200111	920B 11	11	16,1	38	21,7	7,0	52
009200112	920B 12	12	17,5	38	21,7	8,0	54
009200113	920B 13	13	18,7	38	21,7	8,0	52,5
009200114	920B 14	14	20,1	38	21,7	10,0	56
009200115	920B 15	15	21,5	38	22,5	10,0	63
009200116	920B 16	16	22,7	38	23,7	10,0	68
009200117	920B 17	17	24,1	38	23,1	10,0	73
009200118	920B 18	18	25,3	39	24,0	12,0	81
009200119	920B 19	19	26,6	39	24,0	12,0	79
009200120	920B 20	20	27,8	40	25,0	12,0	95
009200121	920B 21	21	28,8	40	25,0	14,0	100
009200122	920B 22	22	29,9	41	26,0	14,0	110
009200123	920B 23	23	30,8	42	26,0	14,0	109
009200124	920B 24	24	32,2	43	27,0	16,0	135
009200125	920B 25	25	33,2	44	27,0	16,0	152
009200126	920B 26	26	34,7	45	28,0	16,0	165
009200127	920B 27	27	36,2	46	29,0	18,0	170
009200128	920B 28	28	37,2	47	30,0	18,0	205
009200129	920B 29	29	38,6	48	31,0	18,0	219
009200130	920B 30	30	40,2	48	32,0	20,0	209
009200132	920B 32	32	42,3	49	33,9	22,0	236,4

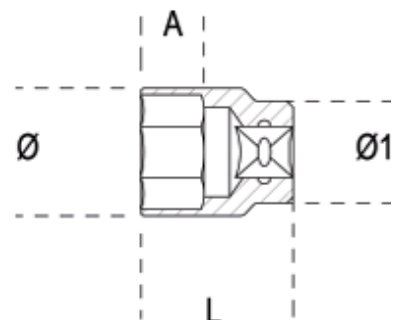

VASOS 1/2"

Vaso estándar en pulgadas 1/2" multicara

920AS

llaves de vaso de mano boca poligonal

12"



Familia 0870

Referencia	art.	"	Ø mm	L mm	Ø1 mm	A mm	g
009200201	920AS 3/8	3/8	14,9	38	21,7	6,0	49
009200202	920AS 7/16	7/16	16,1	38	21,7	7,0	50
009200203	920AS 1/2	1/2	18,7	38	21,7	8,0	52,7
009200204	920AS 9/16	9/16	20,1	38	21,7	10,0	53,6
009200206	920AS 5/8	5/8	22,7	38	22,5	10,0	69,6
009200207	920AS 19/32	19/32	21,5	38	23,7	10,0	60,6
009200208	920AS 11/16	11/16	25,3	39	24,0	12,0	82
009200209	920AS 3/4	3/4	26,6	39	24,0	12,0	80,5
009200210	920AS 25/32	25/32	27,8	40	25,0	12,0	94,5
009200211	920AS 13/16	13/16	28,8	40	25,0	14,0	95,9
009200212	920AS 7/8	7/8	29,9	41	26,0	14,0	114,2
009200214	920AS 15/16	15/16	32,2	43	27,0	16,0	151
009200216	920AS 1	1	34,2	45	28,0	16,0	170
009200217	920AS 1.1/16	1.1/16	36,2	46	29,0	18,0	187
009200218	920AS 1.1/8	1.1/8	38,6	48	31,0	18,0	239
009200219	920AS 1.3/16	1.3/16	40,2	48	32,0	20,0	205
009200220	920AS 1.1/4	1.1/4	42,3	49	33,5	22,0	258

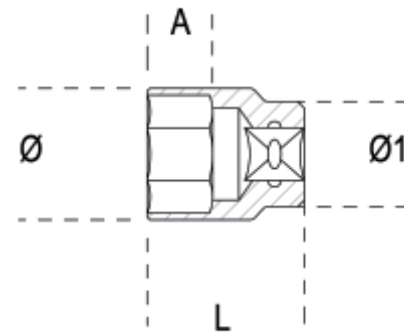

Vaso largo en métrico 1/2" hexagonal

920AL

llaves de vaso de mano tipo largo boca hexagonal

12"



Familia 0870

Referencia	art.	mm	Ø mm	L mm	Ø1 mm	A mm	g
009200626	920AL 10	10	14,7	77	21	12	54
009200627	920AL 12	12	17,8	77	21	12	60
009200628	920AL 13	13	19,0	77	22	12	61
009200629	920AL 14	14	20,3	77	22	15	63
009200630	920AL 15	15	21,5	77	22	15	68
009200631	920AL 16	16	22,8	77	22	15	79
009200632	920AL 17	17	24,0	77	23	15	80
009200633	920AL 18	18	25,0	77	24	18	86
009200634	920AL 19	19	26,5	77	25	18	92
009200635	920AL 21	21	29,0	77	27	18	109
009200636	920AL 22	22	30,0	77	28	21	121
009200637	920AL 23	23	31,5	77	29	21	124
009200638	920AL 24	24	32,8	77	30	24	158
009200639	920AL 27	27	36,5	77	33	27	191
009200640	920AL 30	30	40,0	77	36	30	264
009200641	920AL 32	32	42,8	77	38	33	291
009200642	920AL 36	36	48,0	77	41	34	305

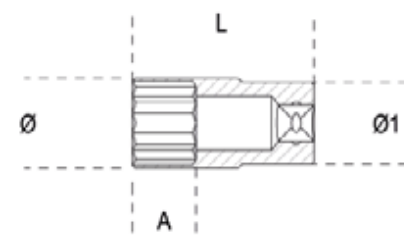

VASOS 1/2"

Vaso largo en métrico 1/2" multicara

920BL

llaves de vaso de mano tipo largo boca poligonal

12"



Familia 0870

Referencia	art.	mm	Ø mm	L mm	Ø1 mm	A mm	g
009200310	920BL 10	10	14,7	77	21	12	74
009200312	920BL 12	12	17,8	77	21	12	106
009200313	920BL 13	13	19,0	77	22	12	116
009200314	920BL 14	14	20,3	77	22	15	124
009200315	920BL 15	15	21,5	77	22	15	123,8
009200316	920BL 16	16	22,8	77	22	15	130
009200317	920BL 17	17	24,0	77	23	15	140
009200318	920BL 18	18	25,0	77	24	18	156
009200319	920BL 19	19	26,5	77	25	18	168
009200321	920BL 21	21	29,0	77	27	18	197
009200322	920BL 22	22	30,0	77	28	21	193,5
009200323	920BL 23	23	31,5	77	29	21	235,8
009200324	920BL 24	24	32,8	77	30	24	247
009200327	920BL 27	27	36,5	77	33	27	298
009200330	920BL 30	30	40,0	77	36	30	345
009200332	920BL 32	32	42,8	77	38	33	392,5
009200336	920BL 36	36	48,0	77	41	34	446,6

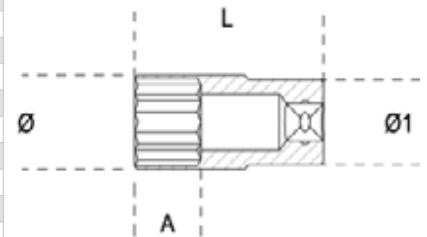

Vaso largo en pulgadas 1/2" multicara

920AS/L

llaves de vaso de mano tipo largo boca poligonal

12"



Familia 0870

Referencia	art.	"	Ø mm	L mm	Ø1 mm	A mm	g
009200352	920AS-L 1/2	1/2	19,0	77	22	12,0	108,2
009200353	920AS-L 9/16	9/16	20,3	77	22	15,0	111,8
009200355	920AS-L 5/8	5/8	22,8	77	22	15,0	137,2
009200357	920AS-L 11/16	11/16	25,0	77	24	18,0	156
009200358	920AS-L 3/4	3/4	26,5	77	25	18,0	172,1
009200360	920AS-L 13/16	13/16	29,0	77	27	18,0	201
009200361	920AS-L 7/8	7/8	30,0	77	28	21,0	185,5
009200362	920AS-L 15/16	15/16	32,8	77	30	24,0	250
009200363	920AS-L 1	1	35,0	77	32	24,0	276
009200364	920AS-L 1.1/16	1.1/16	36,5	77	33,0	25,0	296
009200365	920AS-L 1.1/8	1.1/8	37,8	77	34	27,0	314

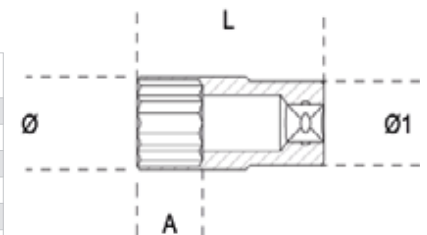

VASOS 1/2"

Vaso estándar para tornillos macho Torx 1/2"

920FTX

llaves de vasos de mano para tornillos con perfil Torx®

12"



Familia 0870



Referencia	art.	⊙	Ø mm	L mm	Ø1 mm	A mm	g
009200380	920FTX 10	E10	13,2	36	21	6,4	44,8
009200381	920FTX 12	E12	15,0	37	21	8,0	46,4
009200382	920FTX 14	E14	16,3	37	21	8,8	48
009200383	920FTX 16	E16	18,8	37	22	9,6	56,8
009200384	920FTX 18	E18	20,4	37	22	11,1	57,2
009200385	920FTX 20	E20	22,9	37	22	12,7	62,8
009200387	920FTX 22	E22	25,0	37	24	16,5	80
009200388	920FTX 24	E24	26,5	40	25	16,9	95

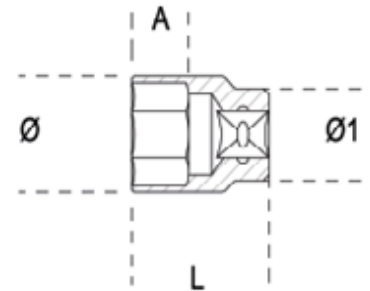

Vaso largo para tornillos macho Torx 1/2"

920FTX/L

llaves de vasos largos para tornillos con perfil Torx®

12"



Familia 0870



Referencia	art.	⊙	Ø mm	L mm	Ø1 mm	A mm	g
009200400	920FTX-L 10	E10	13,2	77	21,0	6,4	85
009200401	920FTX-L 12	E12	15,0	77	21,0	8	88,2
009200402	920FTX-L 14	E14	16,3	77	21,0	8,8	100,2
009200403	920FTX-L 16	E16	18,8	77	21,8	9,6	125,8
009200404	920FTX-L 18	E18	20,4	77	21,8	11,1	129,4
009200405	920FTX-L 20	E20	22,9	77	22,0	12,7	152,6

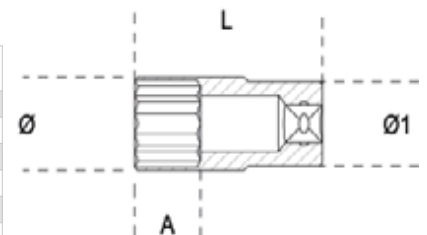

VASOS 1/2"

Vaso con punta ranurada 1/2"

920LP

vasos destornilladores para tornillos ranurados

12"



Familia 0870



Referencia	art.	SxA mm	Ø mm	L mm	L1 mm	g
009200452	920LP 1X5,5	1x5,5	22,5	62	24	65,5
009200453	920LP 1,2X6,5	1,2x6,5	22,5	62	24	68,2
009200454	920LP 1,2X8	1,2x8	22,5	62	24	70,7
009200456	920LP 1,6X9	1,6x9	22,5	62	24	68
009200458	920LP 2X12	2x12	22,5	62	24	78,9

Vaso con punta Phillips 1/2"

920PH

vasos destornilladores para tornillos con huella de cruz Phillips®

12"



Familia 0870



Referencia	art.	PH	Ø mm	L mm	L1 mm	g
009200471	920PH 1	1	22,5	56	18	65
009200472	920PH 2	2	22,5	56	18	65,4
009200473	920PH 3	3	22,5	56	18	65,6
009200474	920PH 4	4	22,5	56	18	73,9

VASOS 1/2"

Vaso con punta hexagonal 1/2"

920PE

vasos macho hexagonales cortos y largos

12"



Familia 0870

Referencia	art.	mm	Ø mm	L mm	L1 mm	g
009200410	920PE 3	3	22,5	58	20	62,3
009200412	920PE 4	4	22,5	58	20	62,5
009200414	920PE 5	5	22,5	58	20	65
009200415	920PE 5L	5L	22,5	100	62	84,8
009200417	920PE 6	6	22,5	58	20	66
009200418	920PE 6L	6L	22,5	100	62	85,7
009200420	920PE 7	7	22,5	58	20	69
009200421	920PE 7L	7L	22,5	100	62	85
009200423	920PE 8	8	22,5	58	20	68,5
009200424	920PE 8L	8L	22,5	100	62	88,1
009200425	920PE 9	9	22,5	58	20	78,4
009200426	920PE 9L	9L	22,5	140	102	136
009200428	920PE 10	10	22,5	58	20	76,9
009200429	920PE 10L	10L	22,5	140	102	136
009200432	920PE 12	12	23,0	58	20	115
009200433	920PE 12L	12L	22,5	140	102	118
009200434	920PE 14	14	23,0	58	20	121
009200435	920PE 14L	14L	22,5	140	102	130
009200437	920PE 17	17	29,5	60	22	186
009200439	920PE 19	19	29,5	60	22	190

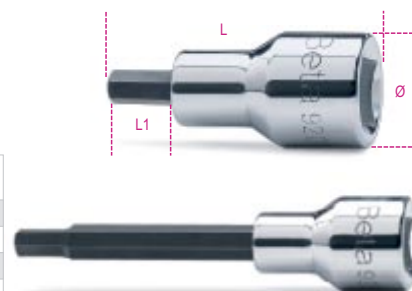

VASOS 1/2"

Vaso con punta Torx 1/2"

920TX

vasos macho para tornillos con huella Torx® cortos y largos



Familia 0870



Referencia	art.	⊙	∅ mm	L mm	L1 mm	g
009200520	920TX 20	T20	22,5	58	20	62,9
009200530	920TX-L 20	T20L	22,5	120	82	
009200521	920TX 25	T25	22,5	58	20	64
009200531	920TX-L 25	T25L	22,5	120	82	
009200522	920TX 27	T27	22,5	58	20	63
009200533	920TX-L 27	T27L	22,5	120	82	
009200523	920TX 30	T30	22,5	58	20	65,4
009200534	920TX-L 30	T30L	22,5	120	82	
009200524	920TX 40	T40	22,5	58	20	65,2
009200535	920TX-L 40	T40L	22,5	120	82	92
009200525	920TX 45	T45	22,5	58	20	69
009200537	920TX-L 45	T45L	22,5	120	82	93
009200526	920TX 50	T50	22,5	58	20	77
009200538	920TX-L 50	T50L	23,0	140	102	
009200527	920TX 55	T55	23,0	58	20	110
009200539	920TX-L 55	T55L	23,0	140	102	217
009200528	920TX 60	T60	23,0	58	20	113
009200540	920TX-L 60	T60L	23,0	140	102	
009200541	920TX-L 70	T70L	23,0	120	82	198,2



Vaso con punta Torx Inviolable 1/2"

920RTX

vasos macho para tornillos con huella Tamper Resistant Torx®



Familia 0870



Referencia	art.	⊙	∅ mm	L mm	L1 mm	g
009200370	920RTX 20	T20	22,5	58	20	66,2
009200371	920RTX 25	T25	22,5	58	20	66,4
009200372	920RTX 27	T27	22,5	58	20	66,2
009200373	920RTX 30	T30	22,5	58	20	66,2
009200374	920RTX 40	T40	22,5	58	20	67

VASOS 1/2"

Vaso con Punta XZN 1/2"

920XZN

vasos macho con perfil XZN® cortos y largos

12"



Familia 0870



Referencia	art.	Ø	Ø mm	L mm	L1 mm	g
009200559	920XZN 4	M4	22,5	58	20	63,2
009200560	920XZN 5	M5	22,5	58	20	62,8
009200561	920XZN 6	M6	22,5	58	20	63,9
009200562	920XZN 6L	M6L	22,5	100	62	85
009200563	920XZN 8	M8	22,5	58	20	65,1
009200564	920XZN 8L	M8L	22,5	100	62	86,9
009200582	920XZN 9	M9	22,5	58	20	77
009200583	920XZN 9L	M9L	22,5	100	62	105
009200565	920XZN 10	M10	22,5	58	20	80
009200566	920XZN 10L	M10L	22,5	100	62	105,7
009200568	920XZN 12	M12	22,5	58	20	83
009200569	920XZN 12L	M12L	22,5	100	62	114,4
009200571	920XZN 14	M14	23,0	58	20	114,7
009200572	920XZN 14L	M14L	23,0	100	62	162,6
009200573	920XZN 16	M16	23,0	58	20	122
009200574	920XZN 18	M18	23,0	58	20	122

Vaso con Punta Ribe 1/2"

920ES

vaso macho para tornillos hexa-acanalados largos y extralargos

12"



Familia 0870



Referencia	art.	Ø mm	Ø	L mm	L1 mm	g
009200587	920ES 7	7	(6R)	58	20	65,8
009200607	920ES-XL 7	7XL	(6R)	240	202	119
009200589	920ES 9	9	(8R)	58	20	70,9
009200609	920ES-XL 9	9XL	(8R)	240	202	180
009200590	920ES 10	10	(8S)	58	20	72,3
009200610	920ES-XL 10	10XL	(8S)	240	202	186
009200591	920ES 11	11	(10R)	58	20	80
009200611	920ES-XL 11	11XL	(10R)	240	202	240
009200592	920ES 12L	12L	(10S)	100	62	120
009200612	920ES-XL 12	12XL	(10S)	240	202	270
009200594	920ES 14L	14L	(12S)	100	62	146
009200614	920ES-XL 14	14XL	(12S)	240	202	342
009200596	920ES 16L	16L	(14R)	100	62	185,4
009200616	920ES-XL 16	16XL	(14R)	240	202	401

VASOS 1/2"

Carraca cabeza redonda 1/2" 48d

920/55Q

carraca reversible con cuadrado macho 1/2", 48 dientes

12"



Familia 0870

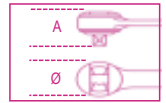

Referencia	art.	L mm	Ø mm	A mm	■	g
009200885	920/55Q	275	40	43	1/2	455

• despiece

Referencia	art.
009200877	920/R55Q



Carraca cabeza redonda 1/2" 72d

920/55

carraca reversible con cuadrado macho 1/2", 72 dientes

12"



Familia 0870

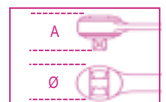

Referencia	art.	L mm	Ø mm	A mm	■	g
009200882	920/55	275	40	43	1/2	475

• despiece

Referencia	art.
009200879	920/R55



VASOS 1/2"

Carraca estándar metal 1/2" 48d

920M/55

carraca reversible con cuadrado macho 1/2" con mango de metal

12"

Familia 0870



Referencia	art.	L mm	Ø mm	A mm	■	g
009200893	920M/55	253	38	35	1/2	580

• despiece

Referencia	art.
009200888	920M/R55



Carraca con cabeza giratoria 1/2" 52d

920/58

carraca reversible con mango giratorio con cuadrado macho 1/2", mecanismo de 52 dientes

12"

Familia 0870

- Sistema de utilización con mango giratorio
- Pulsador para soltar el vaso
- Sistema de inversión de arandela en la cabeza de la carraca
- Mango bimatereial

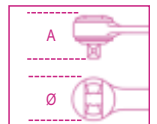

Referencia	art.	L mm	Ø mm	A mm	g
009200926	920/58	281	42,5	45	705

VASOS 1/2"

Extensión estándar 1/2" 75-375mm

920/...

alargaderas con cuadrado macho y hembra 1/2"

12"

Familia 0870

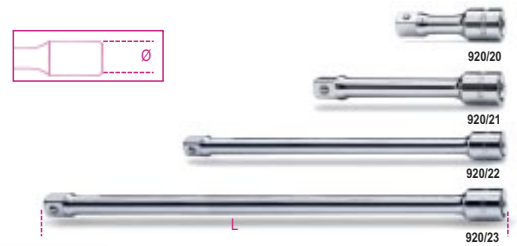

Referencia	art.	L mm	Ø mm	□	■	g
009200818	920/20	75	22	1/2	1/2	105,2
009200822	920/21	125	22	1/2	1/2	163
009200826	920/22	255	22	1/2	1/2	288
009200827	920/23	375	22	1/2	1/2	400

Extensión angular 1/2" 50-375mm

920AN

alargaderas con cuadrado macho y hembra 1/2" angulares

12"

Familia 0870

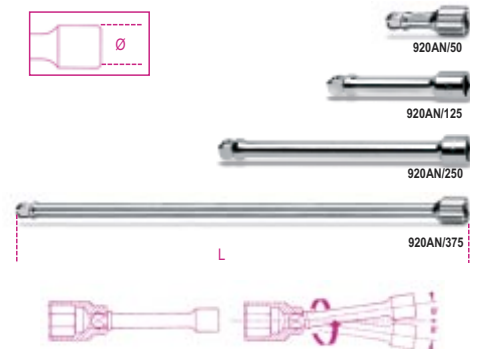

Referencia	art.	L mm	Ø mm	□	■	g
009200833	920AN/50	50	22	1/2	1/2	87
009200834	920AN/125	125	22	1/2	1/2	160
009200835	920AN/250	250	22	1/2	1/2	300
009200836	920AN/375	375	22	1/2	1/2	437,4

VASOS 1/2"

Empuñadura articulada 1/2"

920/35A

mango articulado macho 1/2" con empuñadura

12"

Familia 0870

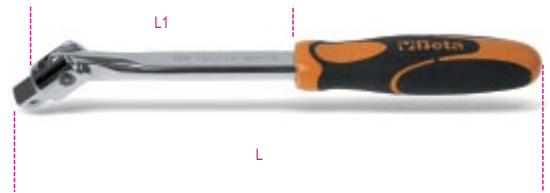

Referencia	art.	L mm	L1 mm	■	g
009200846	920/35A	285	160	1/2	370

Empuñadura corredera 1/2"

920/42

mango corredizo macho 1/2"

12"

Familia 0870

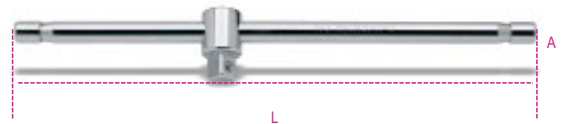

Referencia	art.	L mm	A mm	■	g
009200854	920/42	305	42	1/2	393

VASOS 1/2"

Adaptador porta puntas 1/2"

895

vasos portapuntas para puntas 861 - 862

Familia 0870

Referencia	art.	○	□	L mm	∅ mm	g
008950005	895/5	1/4	1/2	38	22	62



Adaptador porta puntas 1/2"

867

vasos portapuntas para puntas 867 (10 mm)

Familia 0870

Referencia	art.	○	□	L mm	∅ mm	g
008670601	867/2	10	1/2	38	22	50



Cuadrado aumentador 1/2" x 3/4"

920/16

adaptador con cuadrado hembra 1/2" y macho 3/4"

12"

Familia 0870

Referencia	art.	L mm	□	■	∅ mm	g
009200814	920/16	46	1/2	3/4	26	123



VASOS 1/2"

Cuadrado reductor 1/2" x 3/8"

920/15

adaptador con cuadrado hembra 1/2" y macho 3/8"

12"

Familia 0870

¡Es absolutamente necesario aplicar la carga de torsión de manera adecuada y progresiva para evitar roturas o daños accidentales!



Referencia	art.	L mm	□	■	Ø mm	g
009200810	920/15	42	1/2	3/8	22,0	61

Articulación universal 1/2"

920/25

articulación con cuadrado macho y hembra 1/2"

12"

Familia 0870



Referencia	art.	L mm	Ø mm	□	■	g
009200830	920/25	75	27	1/2	1/2	163

VASOS 3/4"

Vaso estándar en métrico 3/4" hexagonal

928A

llaves de vaso de mano boca hexagonal

3/4"



Familia 0870

Referencia	art.	mm	Ø mm	L mm	Ø1 mm	A mm	g
009280019	928A 19	19	29,2	50	34	14,0	173
009280022	928A 22	22	31,3	53	34	14,0	196
009280023	928A 23	23	33,3	53	34	14,0	217
009280024	928A 24	24	34,5	53	34	16,0	211
009280026	928A 26	26	36,8	55	35	16,0	255
009280027	928A 27	27	38,0	56	35	18,0	232
009280028	928A 28	28	39,0	57	35	18,0	252,3
009280029	928A 29	29	40,2	58	35	20,0	243
009280030	928A 30	30	41,5	58	37	20,0	322,5
009280032	928A 32	32	44,3	60	37	22,0	329,8
009280033	928A 33	33	45,8	60	37	24,0	340
009280034	928A 34	34	46,8	60	37	24,0	376
009280035	928A 35	35	48,1	62	38	25,0	374
009280036	928A 36	36	49,5	64	38	26,0	459
009280038	928A 38	38	52,0	68	40	27,0	574
009280041	928A 41	41	56,0	71	40	29,0	651
009280046	928A 46	46	62,3	75	43	32,0	811
009280050	928A 50	50	67,4	80	43	35,0	978
009280055	928A 55	55	73,7	84	48	38,0	1161
009280060	928A 60	60	80,0	87	48	41,0	1333

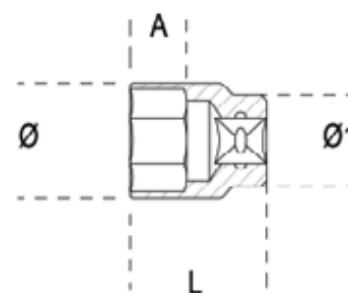

Vaso estándar en pulgadas 3/4" hexagonal

928AS

llaves de vaso de mano boca hexagonal

3/4"



Familia 0870

Referencia	art.	mm	Ø mm	L mm	Ø1 mm	A mm	g
009280202	928AS 7/8	7/8	32,0	53	34	14,0	207
009280203	928AS 15/16	15/16	34,5	53	34	16,0	214
009280204	928AS 1	1	36,2	55	35	16,0	250
009280205	928AS 1.1/16	1.1/16	38,0	56	35	18,0	241
009280206	928AS 1.1/8	1.1/8	40,2	58	35	20,0	254
009280208	928AS 1.1/4	1.1/4	44,2	60	37	22,0	325
009280209	928AS 1.5/16	1.5/16	45,8	60	37	24,0	323
009280210	928AS 1.3/8	1.3/8	48,1	62	38	25,0	433
009280211	928AS 1.7/16	1.7/16	49,5	64	38	26,0	400
009280212	928AS 1.1/2	1.1/2	52,0	68	40	27,0	553
009280214	928AS 1.5/8	1.5/8	56,0	71	40	29,0	667
009280215	928AS 1.11/16	1.11/16	58,8	74	40	29,0	738
009280217	928AS 1.13/16	1.13/16	62,3	75	43	32,0	802
009280218	928AS 1.7/8	1.7/8	65,0	78	43	32,0	875
009280219	928AS 2	2	68,3	80	43	35,0	989
009280220	928AS 2.1/16	2.1/16	71,5	83	48	38,0	1022

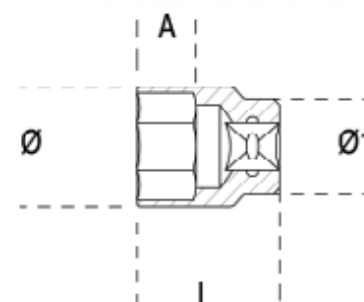

VASOS 3/4"

Vaso estándar en métrico 3/4" multicara

928B

llaves de vaso de mano boca poligonal

3/4"



Familia 0870

Referencia	art.	Ø mm	Ø mm	L mm	Ø1 mm	A mm	g
009280119	928B 19	19	29,2	50	34	14,0	171
009280122	928B 22	22	31,3	53	34	14,0	201,3
009280123	928B 23	23	33,3	53	34	14,0	214,6
009280124	928B 24	24	34,5	53	34	16,0	210
009280126	928B 26	26	36,8	55	35	16,0	255
009280127	928B 27	27	38,0	56	35	18,0	234
009280128	928B 28	28	39,0	57	35	18,0	240
009280129	928B 29	29	40,2	58	35	20,0	243
009280130	928B 30	30	41,5	58	37	20,0	271
009280132	928B 32	32	44,3	60	37	22,0	324,6
009280133	928B 33	33	45,8	60	37	24,0	332,6
009280134	928B 34	34	46,8	60	37	24,0	359
009280135	928B 35	35	48,1	62	38	25,0	367,3
009280136	928B 36	36	49,5	64	38	26,0	474
009280138	928B 38	38	52,0	68	40	27,0	550
009280141	928B 41	41	56,0	71	40	29,0	572
009280146	928B 46	46	62,3	75	43	32,0	728
009280150	928B 50	50	67,4	80	43	35,0	975
009280155	928B 55	55	73,7	84	48	38,0	1129
009280160	928B 60	60	80,0	87	48	41,0	1288

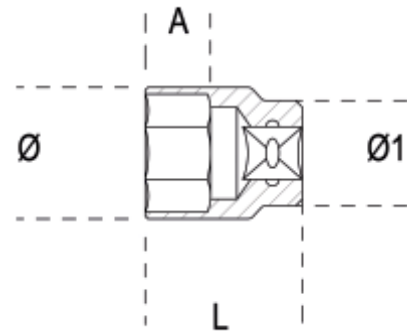

VASOS 3/4"

Vaso con punta hexagonal 3/4"

928ME

vasos macho hexagonales

3/4"



Familia 0870



Referencia	art.	mm	Ø mm	L mm	L1 mm	g
009280514	928ME 14	14	35	75	15,5	268
009280517	928ME 17	17	35	75	15,5	295
009280519	928ME 19	19	35	75	15,5	274
009280522	928ME 22	22	35	75	22,5	388

Carraca cabeza redonda 3/4" 72d

928/55

carraca reversible con cuadrado macho 3/4", 72 dientes

3/4"



Familia 0870



Referencia	art.	L mm	Ø mm	A mm	■	g
009280862	928/55	510	58	59	3/4	1325

VASOS 3/4"

Extensión estándar 3/4" 100-380mm

928/...

alargaderas con cuadrado macho y hembra 3/4"

3/4"

Familia 0870



Referencia	art.	L mm	Ø mm	□	■	g
009280810	928/20	100	34	3/4	3/4	450
009280815	928/21	200	34	3/4	3/4	583
009280825	928/22	380	34	3/4	3/4	1015

Empuñadura articulada metal 3/4"

928/36A

mango articulado macho 3/4"

3/4"

Familia 0870



Referencia	art.	L mm	■	g
009280844	928/36A	545	3/4	1485

VASOS 3/4"

Empuñadura corredera 3/4"

928/42

mango corredizo macho 3/4"

3/4"

Familia 0870

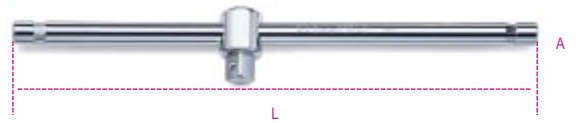

Referencia	art.	L mm	A mm	■	g
009280850	928/42	450	62,5	3/4	1365

Cuadrado aumentador 3/4" x 1"

928/16

adaptador con cuadrado hembra 3/4" y macho 1"

3/4"

Familia 0870



Referencia	art.	L mm	Ø mm	□	■	g
009280807	928/16	65	34	3/4	1"	312

VASOS 3/4"

Cuadrado reductor 3/4" x 1/2"

928/15

adaptador con cuadrado hembra 3/4" y macho 1/2"

3/4"

Familia 0870

¡Es absolutamente necesario aplicar la carga de torsión de manera adecuada y progresiva para evitar roturas o daños accidentales!



Referencia	art.	L mm	Ø mm	□	■	g
009280801	928/15	51,5	34	3/4	1/2	170,2

Articulación universal 3/4"

928/25

articulación con cuadrado macho y hembra 3/4"

3/4"

Familia 0870



Referencia	art.	L mm	Ø mm	□	■
009280830	928/25	108	40	3/4	3/4

VASOS 1"

Vaso estándar en métrico 1" hexagonal

929

llaves de vaso de mano boca hexagonal

1"



Familia 0870



Referencia	art.	mm	Ø mm	L mm	Ø1 mm	A mm	g
009290036	929 36	36	49,5	65	48	26,0	519
009290041	929 41	41	56,0	70	48	29,0	597
009290046	929 46	46	62,0	75	48	32,0	896
009290050	929 50	50	67,5	80	48	35,0	1162
009290055	929 55	55	74,0	85	54	38,0	1409
009290060	929 60	60	80,0	90	54	41,0	1625
009290065	929 65	65	86,0	95	54	44,0	1895
009290070	929 70	70	92,0	100	60	48,0	2420
009290075	929 75	75	99,0	110	60	52,0	2751
009290080	929 80	80	106,0	120	60	56,0	3090

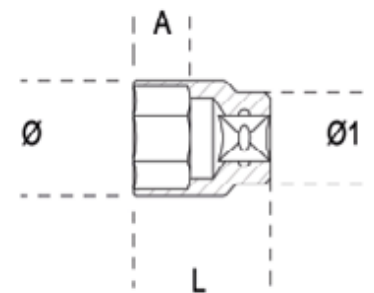

Carraca metal cabeza redonda 1" 72d

929/55

carraca reversible con cuadrado macho 1", 72 dientes

1"



Familia 0870



Referencia	art.	L mm	Ø mm	A mm	■	g
009290860	929/55	770	62	63	1"	2648

VASOS 1"

Extensión estándar 1" 200-400mm

929/...

alargaderas con cuadrado macho y hembra 1"

1"

Familia 0870



929/21



929/22

Referencia	art.	L mm	Ø mm	□	■	g
009290815	929/21	200	47	1"	1"	1064
009290825	929/22	400	47	1"	1"	1855

Empuñadura corredera 1"

929/42

mango corredizo macho 1"

1"

Familia 0870



L

Referencia	art.	L mm
009290850	929/42	535

VASOS 1"

Cuadrado reductor 1" x 3/4"

929/15

adaptador con cuadrado hembra 1" y macho 3/4"

1"

Familia 0870

¡Es absolutamente necesario aplicar la carga de torsión de manera adecuada y progresiva para evitar roturas o daños accidentales!



Referencia	art.	L mm	Ø mm	□	■	g
009290801	929/15	65	47	1"	3/4	429

LLAVES DINAMOMÉTRICAS

Llave dinamométrica 1/4" metálica

605E

llaves dinamométricas de resorte con carraca reversible para aprietes a la derecha y a la izquierda precisión de apriete: $\pm 6\%$

14"

Familia 0870

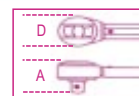

Referencia	Art.	Nm	Kgfm	lbf.ft	■	A mm	L mm	g
006050105	605E/5	1÷5	0,1÷0,5	10÷45	1/4	20	190	180
006050110	605E/10	2÷10	0,2÷1,0	18÷90	1/4	20	190	180

Llave dianamometrica 1/4" - 3/8" - 1/2"

666N

llaves dinamométricas de resorte con carraca reversible para apriete dextrógiro precisión de apriete $\pm 3\%$

Familia 0870

- Escala mayor del 60% para garantizar una mejor visibilidad y un apriete más preciso
- Velocidad de ajuste del par aumentada del 40%
- Material del mango y lente resistentes a todas las sustancias químicas utilizadas en automoción, industria y aviación
- El color verde de la junta tórica indica que la llave está desbloqueada y se puede proceder con el ajuste del par
- En fase de no utilización seleccione el par en el valor más bajo del rango de la llave dinamométrica

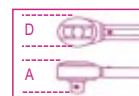

Referencia	Art.	Nm	Kgfm	lbf.ft	■	D mm	A mm	L mm	g
006660002	666N/2	5÷25	0,5÷2,5	4÷18	1/4	25	29	220	300
006660003	666N/2X	5÷25	0,5÷2,5	4÷18	3/8	25	29	220	300
006660005	666N/5	10÷50	1÷5	7÷37	3/8	30	33	325	660
006660010	666N/10	20÷100	2÷10	15÷75	3/8	30	33	367	730
006660011	666N/10X	20÷100	2÷10	15÷75	1/2	30	37	367	800
006660020	666N/20	40÷200	4÷20	30÷150	1/2	40	43	465	1010
006660030	666N/30	60÷300	6÷30	50÷220	1/2	40	43	581	1380

VASOS IMPACTO

Vaso impacto 3/8" hexagonal métrico

710

llaves de vaso de impacto, serie normal



Familia 0870



Referencia	art.	mm	Ø mm	L mm	Ø1 mm	A mm	g
007100007	710 7	7	12,5	28	19	5,0	41
007100008	710 8	8	13,8	28	19	6,0	44
007100009	710 9	9	15,0	28	19	7,0	39,5
007100010	710 10	10	16,3	28	19	7,0	41,3
007100011	710 11	11	17,5	30	19	8,0	42,9
007100012	710 12	12	19,0	30	19	9,0	42
007100013	710 13	13	20,0	30	22	10,0	59
007100014	710 14	14	21,3	30	22	10,0	57,9
007100016	710 16	16	23,8	30	22	11,0	58
007100017	710 17	17	25,0	30	22	12,0	60
007100018	710 18	18	26,3	30	22	12,0	59,5
007100019	710 19	19	27,5	30	22	12,0	69,4
007100021	710 21	21	30,0	32	22	12,0	74
007100022	710 22	22	32,0	32	22	13,0	72,8

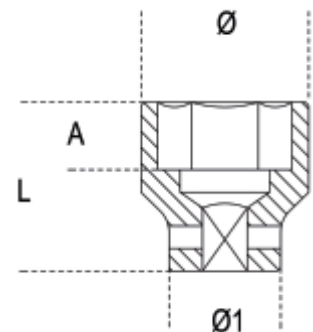

Adaptador agrandador impacto hembra 3/8" macho 1/2"

710/16

adaptador de impacto con cuadrado hembra 3/8" y macho 1/2"



Familia 0870



Referencia	art.	L mm	Ø mm	□	■	g
007100810	710/16	32	22	3/8	1/2	52,4

VASOS IMPACTO

Alargador impacto 3/8" 75mm

710/20

alargadera de impacto con cuadrado macho y hembra 3/8"



Familia 0870



Referencia	art.	L mm	Ø mm	□	■	g
007100821	710/20	75	22	3/8	3/8	90,2

Alargador impacto 3/8" 125mm

710/21

alargadera de impacto con cuadrado macho y hembra 3/8"



Familia 0870



Referencia	art.	L mm	Ø mm	□	■	g
007100823	710/21	125	22	3/8	3/8	138,4

VASOS IMPACTO

Articulación universal impacto 3/8"

710/25

articulación universal de impacto 3/8"

3/8"

Familia 0870



Referencia	art.	L mm	Ø mm	□	■	g
007100830	710/25	58	24	3/8	3/8	111,6

Vaso impacto 1/2" hexagonal métrico

720

llaves de vaso de impacto, serie normal

12"



Familia 0870



Referencia	art.	mm	Ø mm	L mm	Ø1 mm	A mm	g
007200010	720 10	10	17,0	38	25	7,0	85
007200011	720 11	11	18,5	38	25	8,0	86
007200012	720 12	12	20,0	38	25	9,0	85
007200013	720 13	13	21,0	38	25	10,0	84,6
007200014	720 14	14	22,5	38	25	10,0	88
007200015	720 15	15	23,0	38	30	11,0	128,9
007200016	720 16	16	25,0	38	30	11,0	131
007200017	720 17	17	26,0	38	30	12,0	128
007200018	720 18	18	27,5	38	30	13,0	129,6
007200019	720 19	19	28,5	38	30	13,0	123,7
007200021	720 21	21	31,0	38	30	14,0	122,7
007200022	720 22	22	32,5	38	30	14,0	133,6
007200023	720 23	23	34,0	38	30	14,0	134,3
007200024	720 24	24	35,0	38	30	14,0	137
007200027	720 27	27	38,5	45	30	16,0	169
007200030	720 30	30	42,0	50	30	17,0	194,4
007200032	720 32	32	44,0	50	30	18,0	227
007200036	720 36	36	50,0	50	30	18,0	275,8

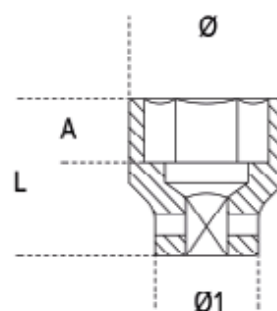

VASOS IMPACTO

Vaso impacto 1/2" hexagonal pulgadas

720AS

llaves de vaso de impacto, serie normal

12"



Familia 0870

Referencia	art.	"	Ø mm	L mm	Ø1 mm	A mm	g
007200210	720AS 3/8	3/8	17,0	38	25	7,0	86,6
007200211	720AS 7/16	7/16	18,2	38	25	8,0	86,3
007200213	720AS 1/2	1/2	20,7	38	25	9,0	85,3
007200214	720AS 9/16	9/16	22,0	38	25	10,0	85
007200216	720AS 5/8	5/8	24,5	38	30	11,0	131
007200217	720AS 11/16	11/16	25,7	38	30	12,0	128
007200219	720AS 3/4	3/4	28,2	38	30	13,0	126,6
007200221	720AS 13/16	13/16	30,7	38	30	14,0	126,6
007200222	720AS 7/8	7/8	32,0	38	30	14,0	129,3
007200224	720AS 15/16	15/16	34,5	38	30	14,0	141,6
007200225	720AS 1	1	35,7	38	30	14,0	141,6
007200227	720AS 1.1/16	1.1/16	38,2	40	30	16,0	163
007200229	720AS 1.1/8	1.1/8	40,7	42	30	17,0	191,3
007200232	720AS 1.1/4	1.1/4	44,5	42	30	18,0	220,3

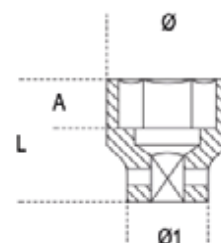

Vaso impacto 1/2" hexagonal Largo métrico

720L

llaves de vaso de impacto, serie larga

12"



Familia 0870

Referencia	art.	mm	Ø mm	L mm	Ø1 mm	A mm	g
007200310	720L 10	10	17,0	80	25	10,0	152
007200311	720L 11	11	18,5	80	25	11,0	156
007200312	720L 12	12	20,0	80	25	12,0	164
007200313	720L 13	13	21,0	80	25	13,0	159,7
007200314	720L 14	14	22,5	80	25	14,0	175,8
007200315	720L 15	15	23,0	80	30	15	227,6
007200316	720L 16	16	25,0	80	30	16,0	233,8
007200317	720L 17	17	26,0	80	30	17,0	247
007200318	720L 18	18	27,5	80	30	18,0	258
007200319	720L 19	19	28,5	80	30	19,0	242
007200321	720L 21	21	31,0	80	30	21,0	261
007200322	720L 22	22	32,5	80	30	22,0	305,3
007200324	720L 24	24	35,0	80	30	24,0	338
007200327	720L 27	27	38,5	80	30	27,0	398
007200330	720L 30	30	42,0	80	30	29	421
007200332	720L 32	32	44,0	80	30	29	457,4
007200336	720L 36	36	50,0	80	30	31	627,4

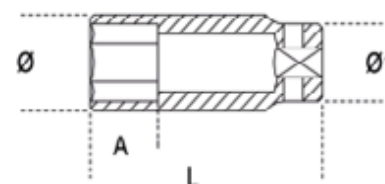

VASOS IMPACTO

Vaso impacto 1/2" hexagonal Largo métrico pared fina

720LS

llaves de vaso de impacto serie larga delgada

12"



Familia 0870



Referencia	art.	Ø mm	D mm	L mm	Ø1 mm	g
007200360	720LS 10	10	15,5	78	24	95
007200361	720LS 11	11	16,7	78	24	98
007200362	720LS 12	12	18,0	78	24	103
007200363	720LS 13	13	19,2	78	24	109
007200364	720LS 14	14	20,5	78	24	115
007200365	720LS 15	15	21,7	78	24	121
007200366	720LS 16	16	23,0	78	24	125
007200367	720LS 17	17	24,2	78	29	173
007200368	720LS 18	18	25,5	78	29	183
007200369	720LS 19	19	26,7	78	29	195
007200371	720LS 21	21	29,2	78	29	200
007200372	720LS 22	22	30,5	78	29	221
007200374	720LS 24	24	33,0	78	29	253
007200377	720LS 27	27	36,7	78	29	301
007200380	720LS 30	30	40,5	78	29	355
007200382	720LS 32	32	43,0	78	29	368
007200386	720LS 36	36	48,0	78	29	420

Juego Vasos impacto 1/2" para llantas aluminio

720LC/C3

3 llaves de vaso de impacto con elementos poliméricos para tuercas de ruedas

12"



Familia 0870

• medidas: 17 - 19 - 21 mm

148x132x44 mm - 860 g

Referencia	art.	
007200653	720LC/C3	17-19-21 mm

• despiece

Referencia	art.	Ø mm	Ø mm	g
007200637	720LC 17	17	26,5	219
007200639	720LC 19	19	28,5	242
007200641	720LC 21	21	30,3	261
007200642	720LC 22	22	32,4	298
007200644	720LC 24	24	34,6	334



VASOS IMPACTO

Vaso impacto 1/2" para tornillos macho Torx

720FTX

llaves de vaso de impacto para tornillos con perfil Torx®

12"



Familia 0870



Referencia	art.	⊙	∅ mm	L mm	∅1 mm	A mm	g
007200410	720FTX 10	E10	14,0	38	25	6,4	87
007200412	720FTX 12	E12	15,9	38	25	8,0	86
007200414	720FTX 14	E14	17,7	38	25	8,8	89
007200416	720FTX 16	E16	20,0	38	25	9,6	88,4
007200418	720FTX 18	E18	22,0	38	25	11,1	90
007200420	720FTX 20	E20	25,0	40	25	12,7	133

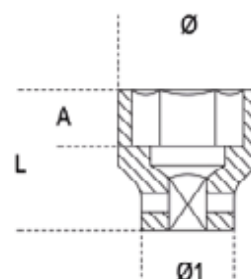

Vaso impacto 1/2" punta Torx

720TX

vasos macho de impacto para tornillos con huella Torx®

12"



Familia 0870



Referencia	art.	⊙	∅ mm	L mm	L1 mm	g
007200460	720TX 30	T30	25	78	54	56,8
007200470	720TX 40	T40	25	78	54	61,6
007200472	720TX 45	T45	25	78	54	68,2
007200474	720TX 50	T50	25	78	54	73,4
007200476	720TX 55	T55	25	78	54	91,4
007200478	720TX 60	T60	25	78	54	99

VASOS IMPACTO

Vaso impacto 1/2" punta hexagonal

720ME

vasos de impacto macho hexagonal

12"



Familia 0870

Referencia	art.	mm	Ø mm	L mm	L1 mm	g
007200505	720ME 5	5	25	78	54	70
007200506	720ME 6	6	25	78	54	72,8
007200508	720ME 8	8	25	78	54	81,8
007200510	720ME 10	10	25	78	54	99,2
007200512	720ME 12	12	25	78	54	114,2
007200514	720ME 14	14	25	78	54	153
007200517	720ME 17	17	25	78	54	190
007200519	720ME 19	19	25	78	54	217,4

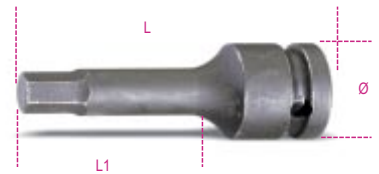

Adaptador reductor impacto hembra 1/2" macho 3/8"

720/15

adaptador de impacto con cuadrado hembra 1/2" y macho 3/8"

12"

Familia 0870

¡Es absolutamente necesario aplicar la carga de torsión de manera adecuada para evitar roturas o daños accidentales!



Referencia	art.	L mm	Ø mm	□	■	g
007200810	720/15	37,5	25	1/2	3/8	68

VASOS IMPACTO

Adaptador agrandador impacto hembra 1/2" macho 3/4"

720/16

adaptador de impacto con cuadrado hembra 1/2" y macho 3/4"

12"

Familia 0870



Referencia	art.	L mm	Ø mm	□	■	g
007200814	720/16	44	30	1/2	3/4	150

Alargadera impacto 1/2" 75mm

720/20

Alargadera de impacto con cuadrado macho y hembra 1/2"

12"

Familia 0870



Referencia	art.	L mm	Ø mm	□	■	g
007200818	720/20	75	25	1/2	1/2	198

VASOS IMPACTO

Alargadera impacto 1/2" 125mm

720/21

Alargadera de impacto con cuadrado macho y hembra 1/2"

12"

Familia 0870



Referencia	art.	L mm	Ø mm	□	■	g
007200822	720/21	125	25	1/2	1/2	276,5

Articulación universal impacto 1/2"

720/25

articulación de impacto con cuadrado macho y hembra 1/2"

12"

Familia 0870



Referencia	art.	L mm	Ø mm
007200831	720/25	64	28

VASOS IMPACTO

Vaso impacto 3/4" hexagonal métrico

728

llaves de vaso de impacto, serie normal

3/4"



Familia 0870

Referencia	art.	mm	Ø mm	L mm	Ø1 mm	A mm	g
007280017	728 17	17	30,0	51	44	14	378
007280018	728 18	18	31,0	51	44	14	377
007280019	728 19	19	32,5	51	44	14	381
007280021	728 21	21	35,0	51	44	14	380
007280022	728 22	22	36,0	51	44	14	383
007280023	728 23	23	37,5	51	44	14	382
007280024	728 24	24	38,5	51	44	14	382
007280027	728 27	27	42,5	53	44	20	382
007280028	728 28	28	44,0	53	44	20	387
007280030	728 30	30	46,0	53	44	20	418
007280032	728 32	32	48,5	57	44	21	432
007280033	728 33	33	50,0	57	44	21	476
007280034	728 34	34	51,0	57	44	21	483
007280035	728 35	35	52,5	57	44	21	497
007280036	728 36	36	53,5	57	44	21	515
007280038	728 38	38	56,0	57	44	21	559
007280040	728 40	40	58,5	58	44	22	602
007280041	728 41	41	60,0	58	44	22	609
007280044	728 44	44	64,0	62	44	25	734
007280045	728 45	45	65,0	62	44	25	745
007280046	728 46	46	66,0	62	44	25	766
007280050	728 50	50	71,0	68	54	30	943
007280055	728 55	55	77,5	71	54	32	830
007280060	728 60	60	83,0	73	54	34	830
007280065	728 65	65	88,0	78	54	38	

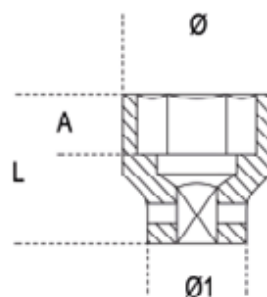

Vaso impacto 3/4" hexagonal Largo métrico

728L

llaves de vaso de impacto, serie larga

3/4"



Familia 0870

Referencia	art.	mm	D mm	L mm	Ø1 mm	A mm	g
007280319	728L 19	19	32,5	90	44	26	656
007280321	728L 21	21	35,0	90	44	26	679
007280322	728L 22	22	36,0	90	44	26	689
007280324	728L 24	24	38,5	90	44	26	691
007280326	728L 26	26	41,0	90	44	28	739
007280327	728L 27	27	42,5	90	44	28	758
007280330	728L 30	30	46,0	90	44	28	802
007280332	728L 32	32	48,5	90	44	28	822
007280333	728L 33	33	50,0	90	44	30	876
007280334	728L 34	34	51,0	90	44	30	900
007280336	728L 36	36	53,5	90	44	30	927
007280338	728L 38	38	56,0	90	44	34	998
007280341	728L 41	41	60,0	90	44	34	1085
007280346	728L 46	46	66,0	90	44	34	1095
007280350	728L 50	50	71,0	90	44	36	1150
007280355	728L 55	55	77,5	100	54	40	1250

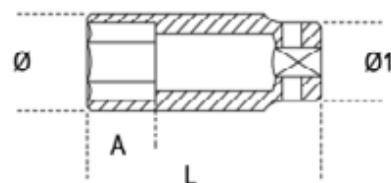

VASOS IMPACTO

Vaso impacto 3/4" hexagonal Largo métrico pared fina

728LS

llaves de vaso de impacto serie larga delgada

3/4"



Familia 0870



Referencia	art.	mm	D mm	L mm	Ø1 mm	A mm	g
007280517	728LS 17	17	28,0	100	43	17	548,7
007280519	728LS 19	19	30,5	100	43	19	564,7
007280522	728LS 22	22	34,3	100	43	22	611,3
007280524	728LS 24	24	36,8	100	43	24	637
007280527	728LS 27	27	40,5	100	43	27	674,3
007280530	728LS 30	30	44,3	100	43	30	683,7
007280532	728LS 32	32	46,8	100	43	32	742,3
007280533	728LS 33	33	48,0	100	43	33	753,3
007280536	728LS 36	36	51,8	100	43	36	787,3

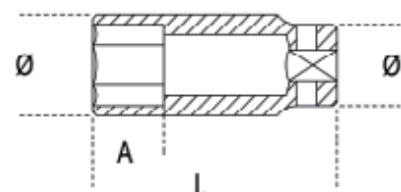

Vaso impacto 3/4" para tornillos macho Torx

728FTX

llaves de vaso de impacto para tornillos con perfil Torx®

3/4"



Familia 0870



Referencia	art.	mm	Ø mm	L mm	Ø1 mm	A mm	g
007280420	728FTX 20	E20	28,5	50	44	13	372,5
007280422	728FTX 22	E22	30,0	50	44	15	371,5
007280424	728FTX 24	E24	32,5	50	44	16	378,5

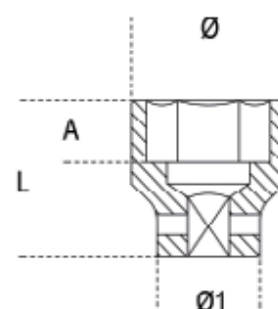

VASOS IMPACTO

Adaptador reductor impacto hembra 3/4" macho 1/2"

728/15

adaptador de impacto con cuadrado hembra 3/4" y macho 1/2"

3/4"

Familia 0870

¡Es absolutamente necesario aplicar la carga de torsión de manera adecuada para evitar roturas o daños accidentales!



Referencia	art.	L mm	Ø mm	□	■	g
007280810	728/15	58	38	3/4	1/2	307

Adaptador agrandador impacto hembra 3/4" macho 1"

728/16

adaptador de impacto con cuadrado hembra 3/4" y macho 1"

3/4"

Familia 0870



Referencia	art.	L mm	Ø mm	□	■	g
007280813	728/16	62	44	3/4	1	435

VASOS IMPACTO

Alargador impacto 3/4" 175mm

728/21

alargadera de impacto con cuadrado macho y hembra 3/4"

3/4"

Familia 0870



Referencia	art.	L mm	Ø mm	□	■	g
007280815	728/21	175	44	3/4	3/4	883

Alargador impacto 3/4" 250mm

728/22

alargadera de impacto con cuadrado macho y hembra 3/4"

3/4"

Familia 0870



Referencia	art.	L mm	Ø mm	□	■	g
007280825	728/22	250	44	3/4	3/4	1147

VASOS IMPACTO

Alargador impacto 3/4" 330mm

728/22L

alargadera de impacto con cuadrado macho y hembra 3/4"

3/4"

Familia 0870



Referencia	art.	L mm	Ø mm	□	■
007280826	728/22L	330	44	3/4	3/4

Articulación universal impacto 3/4"

728/25

articulación de impacto con cuadrado macho y hembra 3/4"

3/4"

Familia 0870



Referencia	art.	L mm	Ø mm	□	■	g
007280830	728/25	107,5	44	3/4	3/4	713

VASOS IMPACTO

Vaso impacto 1" hexagonal métrico

729

llaves de vaso de impacto, serie normal

1"



Familia 0870

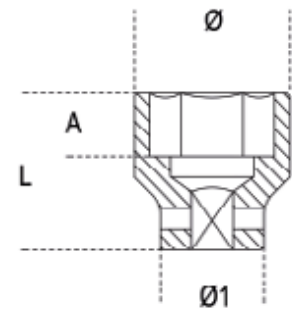

Referencia	art.	mm	D mm	L mm	Ø1 mm	A mm	g
007290024	729 24	24	41,5	58	54	17	629
007290027	729 27	27	45,0	60	54	19	640
007290030	729 30	30	49,0	62	54	22	685
007290032	729 32	32	51,5	63	54	22	687,3
007290033	729 33	33	52,5	63	54	22	691
007290034	729 34	34	54,0	63	54	22	687
007290036	729 36	36	56,5	66	54	22	705
007290038	729 38	38	59,0	66	54	22	802,8
007290041	729 41	41	62,5	68	54	24	853
007290046	729 46	46	69,0	72	54	26	1023
007290050	729 50	50	74,0	76	54	28	1039
007290055	729 55	55	80,0	84	54	36	1293
007290060	729 60	60	86,5	88	54	38	1429
007290065	729 65	65	92,5	92	54	38	2039
007290070	729 70	70	99,0	96	54	40	1702
007290075	729 75	75	105,0	102	63	45	2722
007290080	729 80	80	111,5	102	63	45	3015

Vaso Largo impacto 1" hexagonal métrico

729L

llaves de vaso de impacto, serie larga

1"



Familia 0870

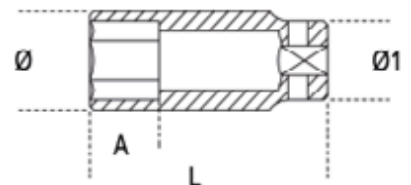

Referencia	art.	mm	D mm	L mm	Ø1 mm	A mm	g
007290324	729L 24	24	41,5	108	54	30	1059
007290327	729L 27	27	45,0	108	54	30	1103
007290330	729L 30	30	49,0	108	54	30	1124
007290332	729L 32	32	51,5	108	54	30	1172
007290333	729L 33	33	52,2	108	54	35	1211
007290334	729L 34	34	54,0	108	54	35	1229
007290336	729L 36	36	56,5	108	54	35	1280
007290341	729L 41	41	62,5	108	54	38	1436
007290346	729L 46	46	69,0	108	54	42	1670
007290350	729L 50	50	74,0	108	54	42	1554
007290355	729L 55	55	80,0	108	54	45	1866
007290360	729L 60	60	86,5	108	54	48	2058
007290365	729L 65	65	92,5	108	54	55	2376
007290370	729L 70	70	99,0	108	54	55	2549
007290375	729L 75	75	105,0	108	63	55	3700
007290380	729L 80	80	111,5	108	63	55	4019

VASOS IMPACTO

Vaso Largo impacto 1" hexagonal métrico pared fina

729LS

llaves de vaso de impacto, serie larga delgada

1"



Familia 0870



Referencia	art.	Ø mm	D mm	L mm	Ø1 mm	A mm	g
007290522	729LS 22	22	36,0	108	53	22	956
007290524	729LS 24	24	38,5	108	53	24	969
007290527	729LS 27	27	42,3	108	53	27	1023
007290530	729LS 30	30	46,0	108	53	30	1063
007290532	729LS 32	32	48,5	108	53	32	1083
007290533	729LS 33	33	49,8	108	53	33	1097
007290536	729LS 36	36	53,5	108	53	36	1123

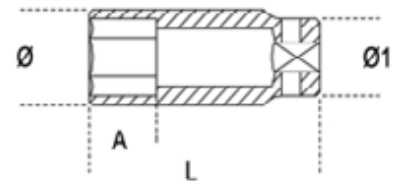

Adaptador reductor impacto hembra 1" macho 3/4"

729/15

adaptador de impacto con cuadrado hembra 1" y macho 3/4"

1"

Familia 0870

¡Es absolutamente necesario aplicar la carga de torsión de manera adecuada y progresiva para evitar roturas o daños accidentales!



Referencia	art.	L mm	Ø mm	□	■	g
007290810	729/15	66,5	54	1	3/4	558

VASOS IMPACTO

Adaptador agrandador impacto hembra 1" macho 1,1/2"

729/16

adaptador de impacto con cuadrado hembra 1" y macho 1.1/2"

1"

Familia 0870



Referencia	art.	L mm	Ø mm	□	■	g
007290813	729/16	88	54,0	1	1.1/2	1057

Alargadera impacto 1" 175mm

729/21

alargadera de impacto con cuadrado macho y hembra 1"

1"

Familia 0870



Referencia	art.	L mm	Ø mm	g
007290815	729/21	175	54	1403

VASOS IMPACTO

Alargadera impacto 1" 330mm

729/22

alargadera de impacto con cuadrado macho y hembra 1"

1"

Familia 0870



Referencia	art.	L mm	Ø mm	□	■	g
007290825	729/22	330	54	1	1	2416

Articulación universal impacto 1"

729/25

articulación de impacto con cuadrado macho y hembra 1"

1"

Familia 0870



Referencia	art.	L mm	Ø mm	□	■	g
007290830	729/25	130	54	1	1	1343

LLAVES

Llaves fijas métrico

55

llaves fijas de dos bocas abiertas

Familia 0870

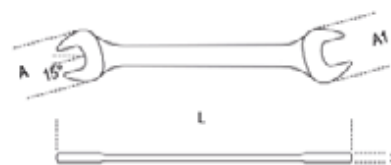

	Referencia	art.	mm	L mm	A mm	A1 mm	S mm	g
	000550003	55 4X5	4x5	101	12,5	14,0	3,0	12
	000550006	55 5X5,5	5x5,5	101	12,5	14,0	3,0	12
	000550009	55 5,5X7	5,5x7	120	15,5	17,5	3,5	21
•	000550012	55 6X7	6x7	120	15,5	17,5	3,5	21
	000550018	55 7X8	7x8	140	19,5	21,5	4,0	32
•	000550021	55 8X9	8x9	140	19,5	21,5	4,0	34
	000550024	55 8X10	8x10	140	19,5	21,5	4,0	34
•	000550030	55 10X11	10x11	155	23,5	25,5	4,5	47
	000550033	55 10X12	10x12	155	23,5	25,5	4,5	45
	000550035	55 10X13	10x13	170	27,5	29,5	5,0	68
•	000550042	55 12X13	12x13	170	27,5	29,5	5,0	69
	000550045	55 12X14	12x14	170	27,5	29,5	5,0	63
	000550047	55 13X14	13x14	185	31,5	33,5	5,5	87
	000550051	55 13X17	13x17	189	31,5	37,5	6,0	114
•	000550054	55 14X15	14x15	185	31,5	33,5	5,5	92
	000550057	55 14X17	14x17	189	31,5	37,5	6,0	99
•	000550060	55 16X17	16x17	202	35,5	37,5	6,0	122
	000550063	55 17X19	17x19	220	39,5	41,5	6,5	147
•	000550066	55 18X19	18x19	220	39,5	41,5	6,5	134
	000550069	55 19X22	19x22	236	43,5	47,5	7,0	204
•	000550075	55 20X22	20x22	236	43,5	47,5	7,0	207
•	000550078	55 21X23	21x23	245	45,5	49,5	7,6	245
	000550081	55 22X24	22x24	245	45,5	49,5	7,6	233
•	000550087	55 24X26	24x26	262	51,5	55,5	8,0	300
	000550090	55 24X27	24x27	262	51,5	55,5	8,0	310
•	000550096	55 25X28	25x28	272	53,5	59,5	8,6	359
•	000550099	55 27X29	27x29	284	57,5	61,5	8,8	393
	000550102	55 27X30	27x30	284	57,5	61,5	8,8	405
	000550105	55 27X32	27x32	297	63,5	67,5	9,0	492
•	000550108	55 30X32	30x32	297	63,5	67,5	9,0	490
	000550114	55 32X36	32x36	325	68,4	76,1	11,0	612
	000550117	55 34X36	34x36	325	68,4	76,1	11,0	614
	000550120	55 35X38	35x38	375	76,0	85,6	13,0	856
	000550123	55 36X41	36x41	375	76,0	85,6	13,0	858
	000550129	55 41X46	41x46	425	85,6	94,8	14,0	1200
	000550132	55 46X50	46x50	475	94,8	104,0	15,0	1785
	000550135	55 50X55	50x55	500	106,8	113,8	16,0	2000
	000550138	55 55X60	55x60	500	106,8	113,8	16	2350

LLAVES

Llaves fijas pulgadas

55AS

llaves fijas de dos bocas abiertas

Familia 0870



Referencia	art.	🔧 "	L mm	A mm	A1 mm	S mm	📏 g
000550203	55AS 1/4X9/32	1/4x9/32	120	15,5	17,5	3,5	21,5
000550206	55AS 1/4X5/16	1/4x5/16	120	15,5	17,5	3,5	21,5
000550209	55AS	5/16x11/32	140	19,5	21,5	4,0	35
000550212	55AS 5/16X3/8	5/16x3/8	140	19,5	21,5	4,0	31
000550215	55AS 3/8X7/16	3/8x7/16	155	23,5	25,5	4,5	47
000550218	55AS 7/16X1/2	7/16x1/2	170	27,5	29,5	5,0	62
000550221	55AS 1/2X9/16	1/2x9/16	170	27,5	29,5	5,0	66
000550224	55AS 9/16X5/8	9/16x5/8	185	31,5	33,5	5,5	87
000550227	55AS	19/32x11/16	189	31,5	37,5	6,0	103
000550230	55AS	5/8x11/16	202	35,5	37,5	6,0	126
000550233	55AS 5/8X3/4	5/8x3/4	202	35,5	37,5	6,0	123
000550242	55AS	11/16x13/16	220	39,5	41,5	6,5	140
000550245	55AS 3/4X7/8	3/4x7/8	236	43,5	47,5	7,0	204
000550244	55AS	25/32x13/16	236	43,5	47,5	7,0	208
000550251	55AS	7/8x15/16	245	45,5	49,5	7,6	256
000550257	55AS 15/16X1	15/16x1	262	51,5	55,5	8,0	306
000550259	55AS 1X1.1/8	1x1.1/8	272	53,5	59,5	8,6	364
000550267	55AS	1.1/16x1.1/4	284	63,5	67,5	8,8	490
000550266	55AS	1.1/8x1.5/16	297	63,5	67,5	9,0	465
000550269	55AS	1.5/16x1.1/2	325	68,4	76,1	11,0	621
000550272	55AS	1.3/8x1.1/2	375	76,0	85,6	13,0	891
000550275	55AS	1.7/16x1.5/8	375	76,0	85,6	13,0	901



LLAVES

Llaves de estrella acodadas de dos bocas métrico

90

llaves de estrella acodadas de dos bocas

Familia 0870



Referencia	art.	mm	L mm	Ø mm	Ø1 mm	H mm	S mm	S1 mm	g
000900006	90 6X7	6x7	165	10,9	12,4	19,0	5,0	5,5	35
000900012	90 8X9	8x9	180	13,9	15,4	20,0	6,0	6,5	44,5
000900015	90 8X10	8x10	180	13,9	15,4	20,0	6,0	6,5	46
000900018	90 10X11	10x11	195	16,6	18,0	22,0	7,0	7,5	71
000900021	90 10X12	10x12	195	16,6	18,0	22,0	7,0	7,5	70
000900024	90 11X13	11x13	215	19,6	21,0	24,0	8,0	8,5	92
000900027	90 12X13	12x13	215	19,6	21,0	24,0	8,0	8,5	106
000900030	90 12X14	12x14	215	19,6	21,0	24,0	8,0	8,5	103
000900033	90 14X15	14x15	230	22,2	23,6	25,0	9,0	9,5	133
000900036	90 14X17	14x17	250	25,0	26,3	28,0	10,0	10,5	176
000900039	90 16X17	16x17	250	25,0	26,3	28,0	10,0	10,5	165
000900042	90 17X19	17x19	265	27,6	29,0	30,0	11,0	11,5	224
000900045	90 18X19	18x19	265	27,6	29,0	30,0	11,0	11,5	214
000900048	90 19X22	19x22	285	30,4	33,2	31,0	12,0	13,0	272
000900051	90 20X22	20x22	285	30,4	33,2	31,0	12,0	13,0	275
000900057	90 21X23	21x23	305	31,8	34,6	32,0	12,5	13,5	315
000900060	90 22X24	22x24	305	31,8	34,6	32,0	12,5	13,5	310
000900063	90 24X26	24x26	325	36,0	40,5	33,7	14,0	15,0	411
000900067	90 24X27	24x27	325	36,0	40,5	33,7	14,0	15,0	405
000900070	90 25X28	25x28	340	37,5	42,0	34,9	14,5	15,5	484
000900073	90 27X29	27x29	355	40,5	44,0	36,8	15,3	16,3	513
000900076	90 27X30	27x30	355	40,5	44,0	36,8	15,3	16,3	487
000900078	90 27X32	27x32	375	44,0	47,0	38,0	16,0	16,5	657
000900080	90 30X32	30x32	375	44,0	47,0	38,0	16,0	16,5	617
000900088	90 32X36	32x36	395	47,5	52,8	38,0	17,0	18,0	739
000900089	90 34X36	34x36	415	51,5	54,5	41,1	18,0	19,0	720
000900091	90 35X38	35x38	415	51,5	54,5	41,1	18,0	19,0	838
000900094	90 36X41	36x41	435	52,8	60,0	43,1	19,0	20,0	941
000900097	90 41X46	41x46	460	60,0	67,5	44,1	20,0	21,0	1546
000900100	90 46X50	46x50	500	67,5	73,5	47,3	21,0	22,0	2038

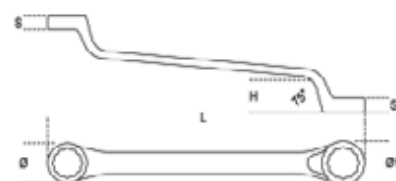

LLAVES

Llaves de estrella acodadas de dos bocas pulgadas

90AS

llaves de estrella acodadas de dos bocas

Familia 0870



Referencia	art.	"	L mm	Ø mm	Ø1 mm	H mm	S mm	S1 mm	g
000900203	90AS	1/4X5/16	165	10,9	12,4	19,0	5,0	5,5	36,5
000900206	90AS	5/16x11/32	180	13,9	15,4	20,0	6,0	6,5	53,5
000900209	90AS	5/16X3/8	180	13,9	15,4	20,0	6,0	6,5	44
000900212	90AS	3/8X7/16	195	16,6	18,0	22,0	7,0	7,5	63
000900215	90AS	7/16X1/2	215	19,6	21,0	24,0	8,0	8,5	88,5
000900218	90AS	1/2X9/16	230	22,2	23,6	25,0	9,0	9,5	135
000900221	90AS	9/16X5/8	230	22,2	23,6	25,0	9,0	9,5	130
000900222	90AS	19/32x11/16	250	25	26,3	28,0	10,0	10,5	178
000900224	90AS	5/8x11/16	250	25,0	26,3	28,0	10,0	10,5	180
000900227	90AS	5/8X3/4	265	27,6	29,0	30,0	11,0	11,5	212
000900230	90AS	11/16x3/4	265	27,6	29,0	30,0	11,0	11,5	215
000900233	90AS	11/16x13/16	265	27,6	29,0	30,0	11,0	11,5	208
000900235	90AS	3/4x25/32	265	27,6	29,0	30,0	11,0	11,5	220
000900237	90AS	3/4X7/8	285	30,4	33,2	31,0	12,0	13,0	273
000900240	90AS	13/16x7/8	285	30,4	33,2	31,0	12,0	13,0	266
000900243	90AS	7/8x15/16	305	31,8	34,6	32,0	12,5	13,5	299
000900252	90AS	15/16X1	325	36,0	40,5	33,7	14,0	15,0	403
000900258	90AS	1.1/16x1.1/4	375	44,0	47,0	38,0	16,0	16,5	656
000900261	90AS	1.1/8x1.5/16	375	44,0	47,0	38,0	16,0	16,5	641

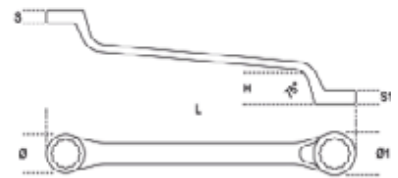

LLAVES

Llaves para tuberías métrico

94

llaves para tuberías

Familia 0870



	Referencia	art.	mm	L mm	Ø mm	Ø1 mm	A mm	A1 mm	S mm	S1 mm	g
○	000940008	94 8X10	8x10	140	17,8	19,3	6,0	7,0	6,5	7,5	40
○	000940009	94 9X11	9x11	153	19,4	21,4	7,0	9,0	8,0	8,5	49
○	000940010	94 10X11	10x11	153	19,4	21,4	7,0	9,0	8,0	8,5	70
○	000940011	94 11X13	11x13	175	21,4	23,5	9,0	8,5	8,5	10,5	80
○	000940012	94 12X14	12x14	175	22,8	25,3	9,0	11,0	8,5	10,5	78
○	000940013	94 13X15	13x15	175	25,7	27,7	10,5	12,1	11,0	11,4	102
	000940014	94 14X15	14x15	175	25,5	27,3	11,0	12,0	10,5	11,0	130
	000940015	94 14X17	14x17	195	27,4	31,4	11,0	14,0	11,0	12,5	140
	000940017	94 17X19	17x19	212	31,2	33,3	14,0	15,0	12,0	13,0	174
	000940019	94 19X22	19x22	228	33,5	38,5	15,0	17,0	13,0	14,0	220
	000940022	94 22X24	22x24	242	38,5	42,0	17,0	18,0	15,0	16,0	314
	000940024	94 24X27	24x27	260	46,6	46,6	18,0	20,0	16,0	17,0	411
	000940030	94 30X32	30x32	300	50,6	52,6	22,0	24,0	19,0	20,5	672
	000940036	94 36X41	36x41	320	61,0	67,5	25,5	32,5	24,5	25,4	772

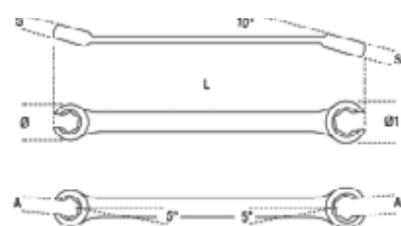

Llaves estrella plana métrico

95

llaves de estrella planas de dos bocas

Familia 0870



Referencia	art.	mm	L mm	Ø mm	Ø1 mm	S mm	g
000950161	95 6X7	6x7	120	9,8	11,0	4,5	15
000950162	95 8X9	8x9	135	12,2	13,5	5,2	25
000950163	95 10X11	10x11	150	15,0	16,5	6,0	36
000950164	95 12X13	12x13	165	18,5	19,5	7,4	51
000950165	95 14X15	14x15	185	21,0	22,5	7,4	69
000950166	95 16X17	16x17	210	24,0	25,0	8,0	92
000950167	95 17X19	17x19	225	25,0	27,5	8,7	109
000950168	95 18X19	18x19	225	26,0	27,5	8,7	120
000950169	95 20X22	20x22	240	29,0	32,0	9,4	145
000950170	95 21X23	21x23	255	30,5	33,5	10,0	173
000950171	95 24X26	24x26	270	35,0	37,5	10,7	217
000950172	95 25X28	25x28	285	36,0	40,0	11,4	256
000950173	95 27X29	27x29	315	38,5	41,5	12,0	318
000950174	95 30X32	30x32	335	43,0	45,5	13,0	394

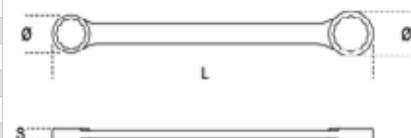

LLAVES

Llaves de pipa dobles hexagonales

933

llaves de pipa dobles hexagonales cromadas brillantes

Familia 0870

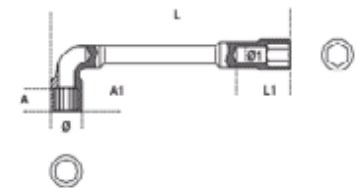

Referencia	art.	mm	Ø mm	L mm	Ø1 mm	A mm	A1 mm	L1 mm	g
009330006	933 6X6	6x6	11,5	110	5,0	8,0	15,0	15,0	55
009330007	933 7X7	7x7	12,5	116	6,0	9,0	18,0	15,0	60
009330008	933 8X8	8x8	13,0	120	6,0	11,0	20,0	21,0	65
009330009	933 9X9	9x9	14,0	125	7,0	11,0	20,0	21,0	75
009330010	933 10X10	10x10	16,5	133	8,0	13,0	22,0	25,0	105
009330011	933 11X11	11x11	17,5	143	8,5	14,0	23,0	25,0	125
009330012	933 12X12	12x12	19,0	148	8,5	14,0	25,0	25,0	165
009330013	933 13X13	13x13	19,5	154	9,5	16,0	28,0	34,0	175
009330014	933 14X14	14x14	21,5	167	10,0	17,0	28,0	34,0	220
009330015	933 15X15	15x15	22,5	182	10,0	17,0	29,0	40,0	235
009330016	933 16X16	16x16	24,5	193	11,0	20,0	33,0	40,0	335
009330017	933 17X17	17x17	26,0	198	12,0	20,0	34,0	44,0	340
009330018	933 18X18	18x18	26,5	215	13,0	20,0	34,0	44,0	370
009330019	933 19X19	19x19	29,0	220	14,0	22,0	35,0	48,0	435
009330020	933 20X20	20x20	30,5	222	14,0	22,0	37,0	48,0	485
009330021	933 21X21	21x21	30,5	236	16,0	25,0	39,0	48,0	575
009330022	933 22X22	22x22	32,5	250	16,0	25,0	41,0	52,0	610
009330023	933 23X23	23x23	33,5	256	17,0	26,0	44,0	52,0	705
009330024	933 24X24	24x24	35,0	272	19,0	27,0	46,0	55,0	805
009330025	933 25X25	25x25	36,5	282	19,0	27,0	47,0	55,0	895
009330026	933 26X26	26x26	37,5	296	20,0	28,0	47,0	61,0	950
009330027	933 27X27	27x27	39,0	296	21,0	28,0	50,0	61,0	1220
009330028	933 28X28	28x28	39,0	314	22,0	28,0	51,0	61,0	1235
009330030	933 30X30	30x30	42,5	348	23,0	31,0	51,0	70,0	1520
009330032	933 32X32	32x32	45,5	364	24,0	32,0	51,0	70,0	1800

LLAVES

Llaves de tubo dos bocas poligonal métrico

930

llaves de tubo de dos bocas serie pesada

Familia 0870



	Referencia	art.	mm	L mm	Ø mm	Ø1 mm	Ø2 mm	A mm	mm	g
○	009300006	930 6X7	6x7	100	9,5	11,0	4,1	7,0	8,0	37
○	009300010	930 8X9	8x9	108	12,5	14,0	5,5	9,0	10,0	55
	009300014	930 10X11	10x11	116	15,0	16,5	7,5	10,0	12,0	75
	009300018	930 12X13	12x13	124	17,5	19,0	9,2	12,0	14,0	100
	009300023	930 14X15	14x15	132	20,0	21,5	9,7	14,0	15,0	132
	009300027	930 16X17	16x17	140	23,0	24,0	10,7	16,0	16,0	140
	009300032	930 18X19	18x19	148	25,0	26,5	12,7	17,0	18,0	210
	009300036	930 20X22	20x22	156	28,0	30,0	14,2	18,0	20,0	255
	009300040	930 21X23	21x23	163	29,0	31,5	16,2	20,0	22,0	290
	009300044	930 24X26	24x26	173	33,0	35,5	17,0	22,0	24,0	405
	009300048	930 25X28	25x28	182	34,5	38,0	19,0	24,0	26,0	495
	009300052	930 27X29	27x29	191	37,0	39,5	21,0	25,0	29,0	590
	009300056	930 30X32	30x32	200	40,5	43,0	23,0	27,0	32,0	730

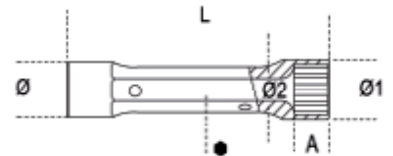

LLAVES

Llaves combinadas en métrico

42

llaves combinadas con una boca fija y otra de estrella acodada

Familia 0870



Referencia	art.	mm	L mm	A mm	Ø mm	S1 mm	S2 mm	g
000420005	42 5,5	5,5x5,5	95	15,2	10,1	3,4	5,2	12
000420006	42 6	6x6	95	15,2	10,1	3,4	5,2	12
000420007	42 7	7x7	105	17,1	10,8	3,6	5,7	16
000420008	42 8	8x8	116	19,0	12,3	3,9	6,2	23
000420009	42 9	9x9	127	20,9	13,7	4,2	6,7	27
000420010	42 10	10x10	137	22,8	15,1	4,5	7,1	35
000420011	42 11	11x11	148	24,8	16,5	4,8	7,5	44
000420012	42 12	12x12	158	26,9	18,2	5,1	7,9	54
000420013	42 13	13x13	169	28,8	19,6	5,4	8,4	66
000420014	42 14	14x14	180	30,8	21,0	5,7	8,8	80
000420015	42 15	15x15	190	32,7	22,4	6,0	9,2	90
000420016	42 16	16x16	201	34,6	23,8	6,3	9,7	105
000420017	42 17	17x17	212	36,6	25,2	6,7	10,2	120
000420018	42 18	18x18	222	38,5	26,7	7,0	10,8	140
000420019	42 19	19x19	233	40,5	28,0	7,3	11,4	160
000420020	42 20	20x20	243	42,5	29,4	7,6	11,9	180
000420021	42 21	21x21	254	44,5	30,7	7,9	12,4	205
000420022	42 22	22x22	264	46,4	32,2	8,1	12,8	225
000420023	42 23	23x23	275	48,4	33,5	8,3	13,2	255
000420024	42 24	24x24	285	50,3	34,9	8,5	13,5	290
000420025	42 25	25x25	296	52,3	36,2	8,7	13,8	310
000420026	42 26	26x26	307	54,3	37,6	8,9	14,2	345
000420027	42 27	27x27	317	56,2	39,0	9,1	14,6	375
000420028	42 28	28x28	328	58,2	40,3	9,3	15,0	400
000420029	42 29	29x29	338	60,2	41,9	9,5	15,3	450
000420030	42 30	30x30	349	62,1	43,0	9,7	15,6	500
000420032	42 32	32x32	370	66,0	45,7	10,1	16,2	565
000420034	42 34	34x34	391	70,0	48,5	10,5	16,8	680
000420035	42 35	35x35	412	73,9	51,3	10,7	17,5	835
000420036	42 36	36x36	412	73,9	51,3	10,9	17,5	825
000420038	42 38	38x38	433	77,9	54,0	11,3	18,2	965
000420041	42 41	41x41	465	83,8	58,0	12,0	19,0	1150

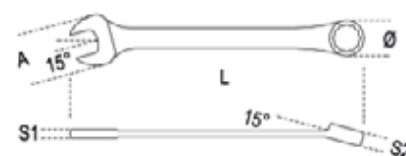

LLAVES

Llave combinada en pulgadas

42AS

llaves combinadas con una boca fija y otra de estrella acodada

Familia 0870



Referencia	art.	"	L mm	A mm	Ø mm	S1 mm	S2 mm	g
000420106	42AS 1/4	1/4x1/4	95	15,2	10,1	3,4	5,2	12
000420107	42AS 9/32	9/32X9/32	106	17,1	11,1	3,6	5,7	18
000420108	42AS 5/16	5/16x5/16	116	19,0	12,3	3,9	6,2	23
000420110	42AS 3/8	3/8x3/8	137	22,8	15,1	4,5	7,1	35
000420111	42AS 7/16	7/16x7/16	148	24,8	16,5	4,8	7,5	44
000420113	42AS 1/2	1/2x1/2	169	28,8	19,6	5,4	8,4	66
000420114	42AS 9/16	9/16x9/16	180	30,8	21,0	5,7	8,8	80
000420115	42AS	19/32X19/32	191	32,7	22,4	6,0	9,2	95
000420116	42AS 5/8	5/8x5/8	201	34,6	23,8	6,3	9,7	105
000420117	42AS 11/16	11/16x11/16	212	36,6	25,2	6,7	10,2	120
000420119	42AS 3/4	3/4x3/4	233	40,5	28,0	7,3	11,4	160
000420121	42AS 13/16	13/16x13/16	254	44,5	30,7	7,9	12,4	205
000420122	42AS 7/8	7/8x7/8	264	46,4	32,2	8,1	12,8	225
000420124	42AS 15/16	15/16x15/16	285	50,3	34,9	8,5	13,5	290
000420125	42AS 1	1x1	296	52,3	36,2	8,7	13,8	310
000420127	42AS 1.1/16	1.1/16x1.1/16	317	56,2	39,0	9,1	14,6	375
000420129	42AS 1.1/8	1.1/8x1.1/8	338	60,2	41,9	9,5	15,3	450
000420132	42AS 1.1/4	1.1/4x1.1/4	370	66,0	45,7	10,1	16,2	565
000420133	42AS 1.5/16	1.5/16x1.5/16	391	70,0	48,5	10,5	16,8	680
000420135	42AS 1.3/8	1.3/8x1.3/8	412	73,9	51,3	10,7	17,5	835
000420136	42AS 1.7/16	1.7/16x1.7/16	412	73,9	51,3	10,9	17,5	825
000420138	42AS 1.1/2	1.1/2x1.1/2	433	77,9	54,0	11,3	18,2	965

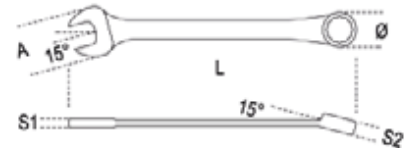

LLAVES

Llave combinada con carraca reversible en pulgadas

142AS

llaves combinadas con carraca reversible

Familia 0870



Referencia	art.	"	L mm	A mm	Ø mm	S1 mm	S2 mm	g
001420308	142AS 5/16	5/16x5/16	136	18,0	18,2	5,1	7,4	36
001420310	142AS 3/8	3/8x3/8	159	22,0	21,5	5,8	7,6	56
001420311	142AS 7/16	7/16x7/16	168	24,5	23,1	6,1	8,2	68
001420313	142AS 1/2	1/2x1/2	180	27,6	26,5	6,7	9,0	96
001420314	142AS 9/16	9/16x9/16	190	31,4	28,3	7,4	9,4	117
001420316	142AS 5/8	5/8x5/8	216	34,6	32,6	8,1	9,9	165
001420317	142AS 11/16	11/16x11/16	233	38,4	34,5	8,8	10,7	196
001420319	142AS 3/4	3/4x3/4	248	41,5	35,6	9,5	11,2	256

Llave combinada con carraca articulada métrico

142SN

llaves combinadas articuladas con carraca

Familia 0870



Referencia	art.	mm	L mm	A mm	Ø mm	S1 mm	S2 mm	g
001420207	142SN 7	7x7	136	18,0	18,2	5,1	7,4	41
001420208	142SN 8	8x8	136	17,1	17,5	4,5	7,0	39
001420209	142SN 9	9x9	143	19,2	19,3	4,8	7,6	44
001420210	142SN 10	10x10	160	21,3	21,0	5,2	7,7	61
001420211	142SN 11	11x11	168	23,7	22,7	5,5	8,3	76
001420212	142SN 12	12x12	174	25,8	24,0	5,8	8,7	91
001420213	142SN 13	13x13	180	26,8	26,0	6,1	9,3	105
001420214	142SN 14	14x14	193	30,4	27,7	6,8	9,4	127
001420215	142SN 15	15x15	200	32,1	29,1	7,2	10,0	146
001420216	142SN 16	16x16	216	33,8	30,7	7,6	10,6	181
001420217	142SN 17	17x17	233	37,0	32,6	8,3	10,6	210
001420218	142SN 18	18x18	239	38,7	33,7	8,6	11,2	228
001420219	142SN 19	19x19	250	40,2	34,8	9,0	11,5	266
001420222	142SN 22	22x22	285	46,5	42,4	10,7	13,0	395
001420224	142SN 24	24x24	325	52,3	47,9	11,5	14,5	550



LLAVES

Llave combinada corta con carraca

142

llaves combinadas con carraca reversible

Familia 0870



Referencia	art.	mm	L mm	A mm	Ø mm	S1 mm	S2 mm	g
001420006	142 6	6x6	136	18,0	18,2	5,1	7,4	40
001420007	142 7	7x7	136	18,0	18,2	5,1	7,4	40
001420008	142 8	8x8	136	18,0	18,2	5,1	7,4	43
001420009	142 9	9x9	143	20,0	19,7	5,4	7,4	44
001420010	142 10	10x10	159	22,0	21,5	5,8	7,6	60
001420011	142 11	11x11	168	24,5	23,1	6,1	8,2	67
001420012	142 12	12x12	174	26,5	24,3	6,4	8,9	93
001420013	142 13	13x13	180	27,6	26,5	6,7	9,0	98
001420014	142 14	14x14	190	31,4	28,3	7,4	9,4	115
001420015	142 15	15x15	200	33,4	29,7	7,7	9,4	143
001420016	142 16	16x16	216	34,6	32,6	8,1	9,9	168
001420017	142 17	17x17	233	38,4	34,5	8,8	10,7	191
001420018	142 18	18x18	239	39,9	34,5	9,0	11,0	210
001420019	142 19	19x19	248	41,5	35,6	9,5	11,2	241
001420021	142 21	21x21	285	45,2	41,4	10,5	13,0	280
001420022	142 22	22x22	285	45,8	42,0	10,2	13,0	344
001420024	142 24	24x24	325	51,5	47,5	11,0	14,5	474
001420027	142 27	27x27	355	59,5	52,0	14,0	14,5	670
001420030	142 30	30x30	420	64,0	59,0	17,0	14,5	1000
001420032	142 32	32x32	420	64,0	59,0	17,0	14,5	1000
* 001420036	142 36	36x36	480	75,0	64,0	18,0	19,0	1500

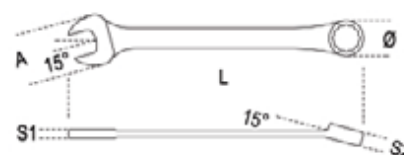

Adaptador portapuntas 1/4" para llaves de carraca 10 mm

123E1/4

adaptador portapuntas 1/4" para llaves de carraca 10 mm



Familia 0870

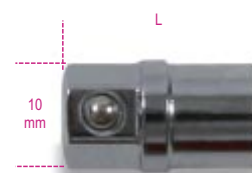

Referencia	art.	mm	L mm	g
001230010	123E1/4	10	20,6	10

LLAVES

Adaptador de desenganche rápido 1/2" para llaves de carraca 19 mm

123Q1/2

adaptador de desenganche rápido 1/2" para llaves de carraca 19mm

12"

Familia 0870

Referencia	art.	∅ mm	L mm	g
001230319	123Q1/2	19	30,5	48

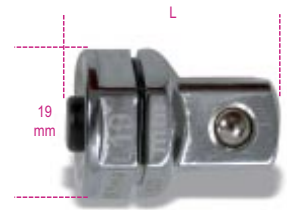

Adaptador de desenganche rápido 3/8" para llaves de carraca 13 mm

123Q3/8

adaptador de desenganche rápido 3/8" para llaves de carraca 13mm

38"

Familia 0870

Referencia	art.	∅ mm	L mm	g
001230313	123Q3/8	13	22,5	17

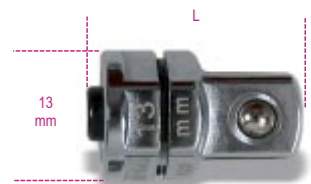

LLAVES

Adaptador de desenganche rápido 1/4" para llaves de carraca 10 mm

123Q1/4

adaptador de desenganche rápido 1/4" para llaves de carraca 10mm

14"

Familia 0870

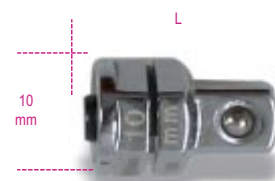

Referencia	art.	∅ mm	L mm	g
001230310	123Q1/4	10	17,5	6

Llaves de estrella dobles rectas de carraca reversible cromadas

192

llaves de estrella dobles rectas de carraca reversible cromadas

Familia 0870

- 4 en 1
- Ángulo de volver de garrar de 5°

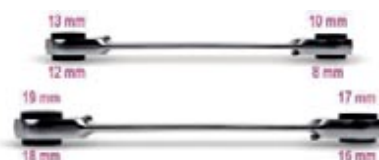

Referencia	art.	∅ mm	L mm	∅ mm	∅1 mm	S mm	S1 mm	g
001920008	192 8-13	8x10/12x13	160	21,0	26,0	14,0	15,0	100
001920016	192 16-19	16x17/18x19	230	34,0	35,5	18,0	20,0	260

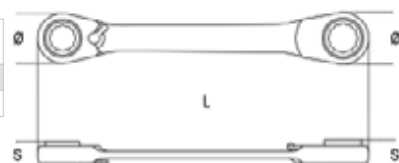

LLAVES

Llaves de carraca poligonales dobles

195

llaves de carraca poligonales dobles

Familia 0870

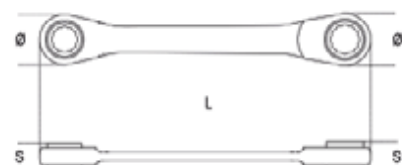

Referencia	art.	mm	L mm	Ø mm	Ø1 mm	S mm	S1 mm	g
001950010	195 8X10	8x10	128	18,2	21,5	7,4	7,6	49
001950013	195 12X13	12x13	170	24,6	26,5	8,9	9,0	100
001950015	195 14X15	14x15	190	28,3	32,6	9,4	9,4	146
001950018	195 16X18	16x18	230	34,5	35,6	9,9	11,0	223
001950019	195 17X19	17x19	230	34,5	35,6	10,7	11,2	226

Llaves inglesas cromadas

111

Llaves inglesas cromadas

Familia 0870

- Apertura de la mordaza móvil con rotación hacia la derecha del mecanismo de ajuste
- Cabeza inclinada de 22,5° con escala milimetrada y en pulgadas

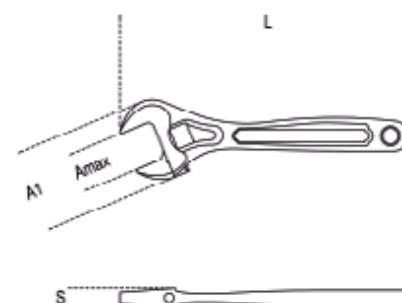

Referencia	art.	L mm	L "	A max mm	A1 mm	S mm	g
001110010	111 100	100	4	15	33,0	9,5	60
001110015	111 150	150	6	24	49,0	11,9	165
001110020	111 200	200	8	28	62,0	14,0	325
001110025	111 250	250	10	34	70,0	16,0	505
001110030	111 300	300	12	35	84,0	18,0	790
001110038	111 380	380	15	45	97,0	20,0	1320
001110045	111 450	450	18	54	115,0	22,5	2043
001110060	111 600	600	24	62	136,0	28,0	3300

LLAVES

Llave modelo Stillson

360

llaves modelo Stillson

Familia 0870



Referencia	art.	L mm	Ø max "	Ø max mm	A mm	S mm	g
003600025	360 250	250	1" gas	34	22	16	520
003600035	360 350	350	1"1/2 gas	49	27	21	1003
003600045	360 450	450	2" gas	60	30	23	1725
003600060	360 600	600	2"1/2 gas	76	38	27	2743
003600090	360 900	900	3"1/2 gas	102	48	30	6062

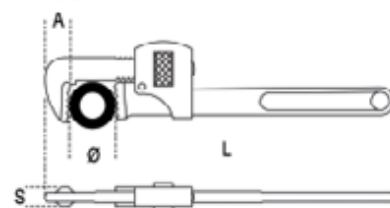

Llave macho acodada hexagonal corta métrico

96

llaves macho hexagonales acodadas cromadas

○ Familia 0870

Referencia	art.	mm	L	L1	g
000960013	96 0,9	0,9	35	8	0,6
000960014	96 1,3	1,3	39	10	0,8
000960015	96 1,5	1,5	45	15	0,9
000960020	96 2	2	50	17	1,8
000960025	96 2,5	2,5	57	20	3
000960030	96 3	3	64	22	4,9
000960035	96 3,5	3,5	68	25	7,2
000960040	96 4	4	72	28	10
000960045	96 4,5	4,5	78	30	13,6
000960050	96 5	5	83	32	17,8
000960055	96 5,5	5,5	88	35	20
000960060	96 6	6	94	37	29
000960070	96 7	7	99	40	41,9
000960080	96 8	8	105	43	58,2
000960090	96 9	9	111	46	78
000960100	96 10	10	119	49	101,4
000960110	96 11	11	126	52	128,2
000960120	96 12	12	134	56	160,1
000960130	96 13	13	142	62	205
000960140	96 14	14	151	69	252
000960160	96 16	16	165	75	367,2
000960170	96 17	17	174	79	428
000960190	96 19	19	196	88	609,6
000960220	96 22	22	216	100	910
000960240	96 24	24	242	112	1192
000960270	96 27	27	271	125	1708
000960300	96 30	30	309	140	2467
000960312	96 32	32	341	155	3038
000960316	96 36	36	385	174	4316



LLAVES

Llave macho acodada hexagonal corta pulgadas

96C/AS

Llaves macho hexagonales acodadas cromadas

○ Familia 0870



Referencia	art.	"	L mm	L1 mm	g
000961702	96C-AS 1/16	1/16	46	16	1,01
000961706	96C-AS 3/32	3/32	53	19	2,70
000961710	96C-AS 1/8	1/8	60	22	5,33
000961714	96C-AS 5/32	5/32	67	25	9,33
000961716	96C-AS 3/16	3/16	74	28	14,87
000961718	96C-AS 7/32	7/32	81	32	22,00
000961720	96C-AS 1/4	1/4	89	35	31,40
000961724	96C-AS 5/16	5/16	103	40	56,16
000961728	96C-AS 3/8	3/8	117	45	91,31

Llave macho acodada hexagonal larga métrico

96LC

llaves macho hexagonales acodadas largas, cromadas

○ Familia 0870



Referencia	art.	mm	L mm	L1 mm	g
000960320	96LC 2	2	101	17	2
000960321	96LC 2,5	2,5	113	20	5,5
000960322	96LC 3	3	127	22	8,8
000960323	96LC 3,5	3,5	138	25	12,5
000960324	96LC 4	4	142	28	17,3
000960325	96LC 4,5	4,5	154	28	23,6
000960326	96LC 5	5	163	32	31
000960327	96LC 6	6	184	37	50,5
000960328	96LC 7	7	194	40	72,5
000960329	96LC 8	8	205	43	101
000960330	96LC 9	9	216	46	134,5
000960331	96LC 10	10	231	49	175
000960332	96LC 12	12	259	56	280

LLAVES

Llave macho acodada hexagonal métrico cabeza bola

96BPC

llaves macho hexagonales acodadas con cabeza esférica, cromadas

○ Familia 0870

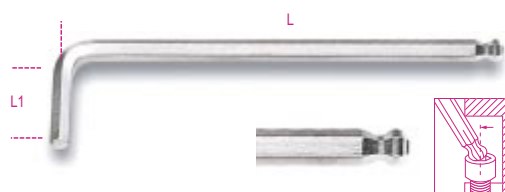

Referencia	art.	mm	L mm	L1 mm	g
000960340	96BPC 1,5	1,5	79	13	1,6
000960341	96BPC 2	2	84	15	2,9
000960342	96BPC 2,5	2,5	89	17	4,7
000960343	96BPC 3	3	99	19	7,5
000960344	96BPC 4	4	108	24	13
000960345	96BPC 5	5	126	27	24
000960346	96BPC 6	6	148	31	40
000960353	96BPC 7	7	157	33	75,2
000960347	96BPC 8	8	168	35	81
000960348	96BPC 10	10	187	39	154,5
000960352	96BPC 12	12	220	55	175

Llave macho acodada hexagonal pulgadas cabeza bola bruñidas

96BP/AS

llaves macho hexagonales acodadas con cabeza esférica, bruñidas

○ Familia 0870

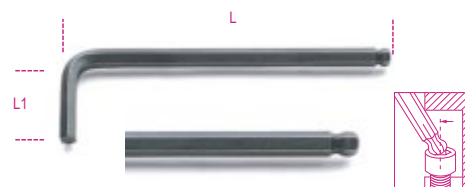

Referencia	art.	"	L mm	L1 mm	g
000960989	96BP-AS 3/32	3/32	89	17	3
000960990	96BP-AS 1/8	1/8	98	18	7,5
000960991	96BP-AS 5/32	5/32	108	24	13,2
000960992	96BP-AS 3/16	3/16	126	26	22
000960993	96BP-AS 7/32	7/32	139	28	34
000960994	96BP-AS 1/4	1/4	152	31	46
000960995	96BP-AS 5/16	5/16	168	34	79
000960996	96BP-AS 3/8	3/8	190	39	126

LLAVES

Llave macho acodada huella Torx

97TX

llaves macho acodadas para tornillos con huella Torx®



Familia 0870



Referencia	art.	⊙	L mm	L1 mm	g
000970006	97TX 06	T6	42	16	3
000970007	97TX 07	T7	48	16	2,3
000970008	97TX 08	T8	48	16	2,3
000970009	97TX 09	T9	48	16	3,2
000970010	97TX 10	T10	51	17	3,5
000970015	97TX 15	T15	54	18	5
000970020	97TX 20	T20	57	19	7,4
000970025	97TX 25	T25	60	20	9,4
000970027	97TX 27	T27	64	21	14,7
000970030	97TX 30	T30	70	24	19,3
000970040	97TX 40	T40	76	26	29,1
000970045	97TX 45	T45	83	29	41,5
000970050	97TX 50	T50	95	32	61
000970055	97TX 55	T55	108	35	121,3
000970060	97TX 60	T60	120	38	186

Llave macho acodada huella Torx inviolable

97RTX

llaves macho acodadas para tornillos con huella Tamper Resistant Torx®



Familia 0870



Referencia	art.	⊙	L mm	L1 mm	g
000970209	97RTX 09	T9	56	16	3,8
000970210	97RTX 10	T10	62	17	4,2
000970215	97RTX 15	T15	72	17	6,2
000970220	97RTX 20	T20	83	18	10
000970225	97RTX 25	T25	90	18	12,6
000970227	97RTX 27	T27	100	20	21
000970230	97RTX 30	T30	105	24	27
000970240	97RTX 40	T40	112	26	40,2

LLAVES

Llave acodada huella XZN

98XZN

llaves macho acodadas con perfil XZN®

○ Familia 0870



Referencia	art.	○	L mm	L1 mm	g
000980005	98XZN 5	M5	83	25	14,5
000980006	98XZN 6	M6	89	30	23,6
000980008	98XZN 8	M8	97	32	46,2
000980010	98XZN 10	M10	106	35	82,6
000980012	98XZN 12	M12	116	37	133
000980014	98XZN 14	M14	118	45	202,6
000980016	98XZN 16	M16	125	45	304

Llaves macho hexagonales métrico acodadas con mango

96T

llaves macho hexagonales acodadas con mango

○ Familia 0870

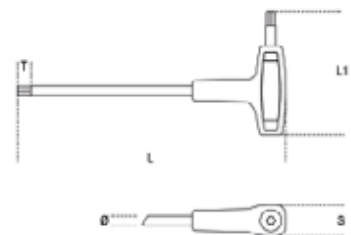

Referencia	art.	mm	L mm	L1 mm	Ø mm	T mm	S mm	g
000960934	96T 2	2	139	52	3	7,0	13,4	13
000960935	96T 2,5	2,5	153	55	4	8,0	13,4	21
000960936	96T 3	3	153	55	4	8,5	13,4	21
000960937	96T 3,5	3,5	179	70	5	9,5	17,8	38
000960938	96T 4	4	179	70	5	10,0	17,8	40
000960939	96T 4,5	4,5	200	84	6	10,5	22	62
000960940	96T 5	5	200	84	6	11,0	22	70
000960941	96T 6	6	221	103	7	12,0	24	97
000960942	96T 7	7	236	106	9	13,0	26	147
000960943	96T 8	8	255	117	10	14,0	26	215
000960945	96T 10	10	285	132	12	16,0	29	338

LLAVES

Llaves macho hexagonales acodadas con cabeza esférica y mango

96TBP

llaves macho hexagonales acodadas con cabeza esférica y mango

○ Familia 0870

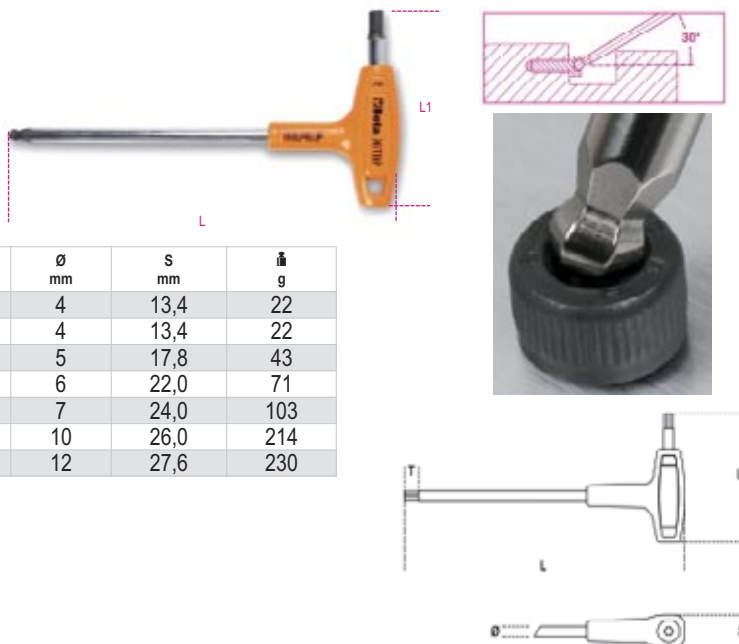

Referencia	art.	mm	L mm	L1 mm	Ø mm	S mm	g
000960685	96TBP 2,5	2,5	153	55	4	13,4	22
000960686	96TBP 3	3	153	55	4	13,4	22
000960687	96TBP 4	4	179	70	5	17,8	43
000960688	96TBP 5	5	200	84	6	22,0	71
000960689	96TBP 6	6	221	103	7	24,0	103
000960690	96TBP 8	8	255	117	10	26,0	214
000960692	96TBP 10	10	285	132	12	27,6	230

Llaves macho acodadas con mango para tornillos con huella Torx

97TTX

llaves macho acodadas con mango para tornillos con huella Torx

○ Familia 0870

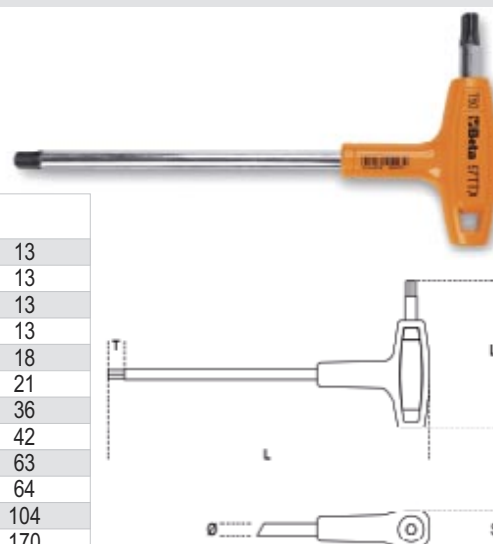

Referencia	art.	Ø	L mm	L1 mm		
000970706	97TTX 06	T6	130	52	13	13
000970707	97TTX 07	T7	130	52	13	13
000970708	97TTX 08	T8	139	52	13	13
000970709	97TTX 09	T9	139	52	13	13
000970710	97TTX 10	T10	179	70	13	18
000970715	97TTX 15	T15	179	70	13	21
000970720	97TTX 20	T20	179	70	18	36
000970725	97TTX 25	T25	179	70	18	42
000970727	97TTX 27	T27	200	84	22	63
000970730	97TTX 30	T30	200	84	22	64
000970740	97TTX 40	T40	221	103	24	104
000970745	97TTX 45	T45	236	106	26	170
000970750	97TTX 50	T50	255	117	26	215

LLAVES

Destornilladores para tornillos con cabeza ranurada

1201E

destornilladores para tornillos con cabeza ranurada



Familia 0870

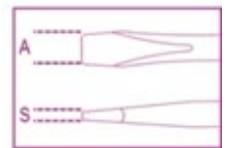

Referencia	art.	SxAxL mm	L1 mm	Ø mm	g
012011003	1201 2,5X50	0,4x2,5x50	146	2,5	35
012011006	1201 2,5X75	0,4x2,5x75	166	2,5	35,5
012011009	1201 3X75	0,5x3x75	171	3,0	37,4
012011012	1201 3X100	0,5x3x100	196	3,0	40
012011018	1201 3,5X75	0,6x3,5x75	171	3,5	41,1
012011021	1201 3,5X100	0,6x3,5x100	196	3,5	41,2
012011030	1201 4X100	0,8x4x100	196	4,0	44,6
012011033	1201 4X125	0,8x4x125	221	4,0	46,6
012011036	1201 4X150	0,8x4x150	246	4,0	50,3
012011039	1201 5,5X100	1,0x5,5x100	209	5,0	68,6
012011040	1201 5,5X125	1,0x5,5x125	234	5,0	70,5
012011042	1201 5,5X150	1,0x5,5x150	259	5,0	75,8
012011048	1201 6,5X100	1,2x6,5x100	220	6,0	95,8
012011050	1201	1,2x6,5x125	234	6,0	
012011051	1201 6,5X150	1,2x6,5x150	270	6,0	104,8
012011057	1201 8X150	1,2x8x150	282	8,0	159
012011060	1201 8X200	1,2x8x200	332	8,0	209,8
012011066	1201 10X200	1,6x10x200	332	9,5	220,6

Destornilladores para tornillos con cabeza ranurada tipo largo

1204EL

Destornilladores para tornillos sin cabeza con ranura, tipo largo



Familia 0870

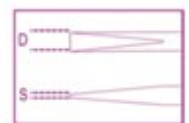

Referencia	art.	SxAxL mm	
012041303	1204L	0,5x2,5x200	300
012041306	1204L	0,5x3x300	400
012041309	1204L	0,8x4x400	508
012041315	1204L	1x5x400	508
012041318	1204L	1,2x6,5x400	519

LLAVES

Destornilladores para tornillos con cabeza ranurada tipo muy corto

1201EN

destornilladores para tornillos con cabeza ranurada tipo muy corto



Familia 0870



Referencia	art.	SxAxL mm	L1 mm	Ø mm	g
012011103	1201N 4X30	0,8x4x30	86,5	4	44
012011106	1201N 6,5X30	1,2x6,5x30	86,5	6	51

Destornilladores para tornillos con huella de cruz Phillips

1202E

destornilladores para tornillos con huella de cruz Phillips®



Familia 0870



Referencia	art.	PHxDxL mm	L1 mm	g
012021003	1202 3X60	0x3x60	156	36,8
012021006	1202 3X100	0x3X100	200	45,8
012021009	1202 4,5X80	1x4,5x80	189	61,6
012021012	1202 4,5X120	1x4,5x120	229	67,2
012021018	1202 6X100	2x6x100	220	94
012021021	1202 6X150	2x6x150	270	105,6
012021024	1202 8X150	3x8x150	282	161
012021027	1202 9,5X200	4x9,5x200	332	243

LLAVES

Destornilladores para tornillos con huella de cruz Phillips tipo largo

1202EL

destornilladores para tornillos con huella de cruz Phillips, tipo largo



Familia 0870

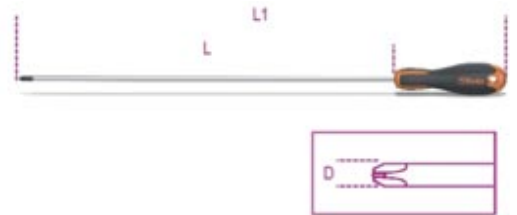

Referencia	art.	PHxDxL mm	L1 mm	g
012021303	1202L	0x3x300	400	47,6
012021305	1202L	1x4,5x300	400	80,5
012021306	1202L	1x4,5x400	508	101,6
012021309	1202L	2x6x400	519	165,3

Destornilladores para tornillos con huella de cruz Phillips tipo muy corto

1202EN

destornilladores para tornillos con huella de cruz Phillips® tipo muy corto



Familia 0870



Referencia	art.	PHxDxL mm	L1 mm	g
012021103	1202N 4,5X30	1x4,5x30	86,5	44
012021106	1202N 6X30	2x6x30	86,5	51

LLAVES

Destornilladores macho hexagonales con mango

1205ES

Llaves macho hexagonales con mango



Familia 0870

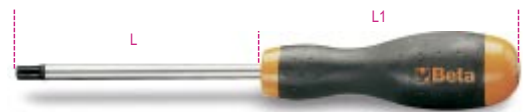

Referencia	art.	mm	L mm	L1 mm
012050315	1205ES	1,5	100	200
012050320	1205ES	2	100	200
012050325	1205ES	2,5	100	200
012050330	1205ES	3	100	200
012050340	1205ES	4	100	208
012050350	1205ES	5	100	219
012050360	1205ES	6	125	244
012050380	1205ES	8	150	277

Llaves macho con mango para tornillos con huella Torx

1207E/TX

llaves macho con mango para tornillos con huella Torx®



Familia 0870

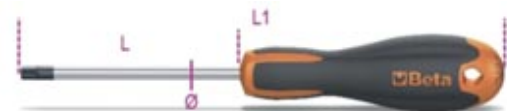

Referencia	art.		L mm	L1 mm	Ø mm	m g
012071005	1207TX	T5	50	150	3	
012071006	1207TX 06	T6	60	156	4	40,4
012071007	1207TX 07	T7	60	156	4	40,4
012071008	1207TX 08	T8	60	156	4	40,6
012071009	1207TX 09	T9	60	156	4	41
012071010	1207TX 10	T10	80	189	5	65
012071015	1207TX 15	T15	80	189	5	65,2
012071020	1207TX 20	T20	100	209	5	69,4
012071025	1207TX 25	T25	100	209	5	69,2
012071027	1207TX 27	T27	100	220	6	95
012071030	1207TX 30	T30	100	220	6	95,2
012071040	1207TX 40	T40	130	262	7	103,5
012071045	1207TX 45	T45	130	262	8	110,1

LLAVES

Llaves macho con mango para tornillos con huella Torx inviolable

1208E/RTX

llaves macho con mango para tornillos con huella Tamper Resistant Torx®



Familia 0870

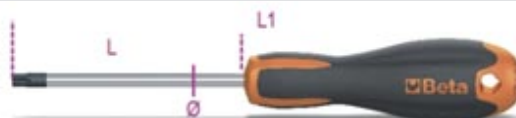

Referencia	art.	⊕	L mm	L1 mm	Ø mm	g
012081009	1208RTX 09	T9	60	156	4	41
012081010	1208RTX 10	T10	80	189	5	65,2
012081015	1208RTX 15	T15	80	189	5	65,6
012081020	1208RTX 20	T20	100	209	5	69
012081025	1208RTX 25	T25	100	209	5	69
012081027	1208RTX 27	T27	100	220	6	94,8
012081030	1208RTX 30	T30	100	220	6	95
012081040	1208RTX 40	T40	130	262	7	108,1

Llaves de pipa hexagonales-poligonales con mango

941

Llaves de pipa hexagonales-poligonales con mango

Familia 0870

- llave de vaso hexagonal profunda en el lado largo



Referencia	art.	⊕	L mm	L1 mm	A1 mm	A mm	S mm	A2 mm	A3 mm	Ø mm
009410107	941 7	7x7	200	91	35	6,0	20,6	15,5	6,0	11,0
009410108	941 8	8x8	220	107	50	7,0	25,2	18,5	7,0	12,2
009410109	941 9	9x9	220	109	50	8,0	25,2	19,5	8,0	13,5
009410110	941 10	10x10	236	111	50	8,5	25,2	20,5	8,5	15,0
009410111	941 11	11x11	236	114	50	9,0	25,2	21,5	9,0	16,0
009410112	941 12	12x12	255	122	50	9,5	27,6	22,5	9,5	17,5
009410113	941 13	13x13	255	124	55	10,5	27,6	23,5	10,5	18,5

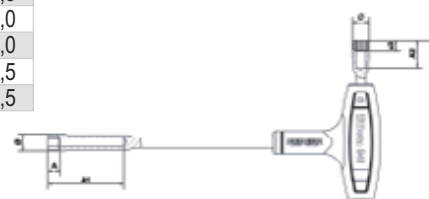

LLAVES

Destornilladores de vaso hexagonales tipo corto cromadas con mango

942BX

Llaves de vaso hexagonales tipo corto cromadas



Familia 0870

- Orificio de descarga interno para maniobrar tuercas con partes roscadas salientes.
- Marcación triple de la medida en la cabeza.

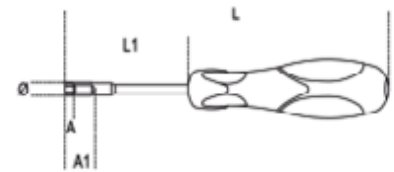

Referencia	art.	Ø mm	L mm	L1 mm	A1 mm	A mm	Ø mm	g
009420003	942BX 4	4	190	70	13,0	3,0	6,5	80
009420004	942BX 5	5	190	70	14,0	3,5	7,6	81
009420005	942BX 5,5	5,5	190	70	12,5	4,0	8,2	90
009420006	942BX 6	6	190	70	14,5	5,0	8,8	90
009420007	942BX 7	7	190	70	15,5	6,0	10,0	91
009420008	942BX 8	8	202	70	18,5	7,0	11,2	120
009420009	942BX 9	9	202	70	19,5	8,0	12,6	123
009420010	942BX 10	10	202	70	20,5	8,5	13,8	133
009420011	942BX 11	11	202	70	21,5	9,0	15,1	138
009420012	942BX 12	12	202	70	22,5	9,5	16,4	157
009420013	942BX 13	13	202	70	23,5	10,5	17,6	160
009420014	942BX 14	14	202	70	24,5	11,5	18,8	176

JUEGOS

Juego de 6 destornilladores para tornillos con cabeza ranurada

1201/S6

juego de 6 destornilladores para tornillos con cabeza ranurada



Familia 0870



Referencia	art.		g
012010206	1201/S6	juego de 6 destornilladores para tornillos con cabeza ranurada (art. 1201) 0,5x3x75-0,6x3,5x100 0,8x4x100-1,0x5,5x100 1,2x8x150-1,6x10x200 mm	670

Juego de 4 destornilladores para tornillos con huella de cruz Phillips

1202/S4

juego de 4 destornilladores para tornillos con huella de cruz Phillips



Familia 0870



Referencia	art.		g
012020204	1202/S4	juego de 4 destornilladores para tornillos con huella de cruz Phillips PH0x3x60-PH1x4,5x120 PH2x6x150-PH3x8x150 mm	430

JUEGOS

Juego de destornilladores para tornillos cabeza ranurada y Phillips

1203/S

juego de destornilladores para tornillos cabeza ranurada y Phillips

Familia 0870



Referencia	art.		g
012030009	1203/S8	destornilladores cabeza ranurada ● 2,5x50-3x75-4x100-5,5x125-6,5x150 mm destornilladores para tornillos con huella de cruz Phillips® ⊕ PH0x3x60-PH1x4,5x80-PH2x6x100 mm	
012030021	1203/S10	destornilladores cabeza ranurada ● 0,4x2,5x50-0,5x3x75 0,8x4x125-1,0x5,5x150 1,2x6,5x150-1,2x8x150 mm destornilladores para tornillos con huella de cruz Phillips® ⊕ PH0x3x60-PH1x4,5x80 PH2x6x100-PH3x8x150 mm	900

Juego de 7 destornilladores macho para tornillos con huella Torx

1207TX/D7

juego de 7 destornilladores macho para tornillos con huella Torx



Familia 0870



Referencia	art.		g
012070207	1207TX/D7	Juego de 7 llaves macho con mango para tornillos con huella Torx T6-T8-T10-T15 T20-T25-T30	560

JUEGOS

Juego de 7 destornilladores macho para tornillos con huella Torx inviolable

1208RTX/D

Juego de 7 destornilladores macho para tornillos con huella Torx inviolable



Familia 0870

Referencia	art.		g
012080207	1208RTX/D7	juego de 7 llaves macho con mango para tornillos con huella Tamper Resistant Torx® T9-T10-T15-T20 T25-T27-T30	610



Juego de 8 microdestornilladores cabeza ranurada y Phillips

1257LPH/S8

Juego de 8 microdestornilladores cabeza ranurada y Phillips

Familia 0870

180x120x50mm 412g



Referencia	art.		
012570210	1257LPH/S8	juego de 8 microdestornilladores PH00 -PH0 - PH1 0,4X2, 0,4X2,5, 0,5X3 0,6X3,5, 0,8X4	

JUEGOS

Juego en bolsa de llaves fijas de dos bocas abiertas

55/B

juego en bolsa de llaves fijas de dos bocas abiertas

Familia 0870



Referencia	art.		g
000550158	55/B8	juego de 8 llaves fijas de dos bocas abiertas en sobre 6x7-8x9-10x11-12x13 14x15-16x17-18x19 20x22 mm	800
000550162	55/B12	juego de 12 llaves fijas de dos bocas abiertas en sobre 6x7-8x9-10x11-12x13 14x15-16x17-18x19 20x22-21x23-24x26 25x28-30x32 mm	2.300

Juego en bolsa de 9 llaves combinadas con una boca fija y otra de estrella

42/B

juego en bolsa de 9 llaves combinadas con una boca fija y otra de estrella

Familia 0870



Referencia	art.		g
000420064	42/B9	juego de 9 llaves combinadas con una boca fija y otra de estrella acodada en sobre 6-7-8-10-11-13-14-17-19 mm	730

JUEGOS

Juego en bolsa de 8 llaves de estrella acodadas de dos bocas

90/B

juego en bolsa de 8 llaves de estrella acodadas de dos bocas

Familia 0870



Referencia	art.		g
000900154	90/B8	juego de 8 llaves de estrella acodadas de dos bocas en sobre 6x7-8x9-10x11-12x13 14x15-16x17-18x19 20x22 mm	1.200

Juego de llaves combinadas con carraca reversible

142/B

juego de llaves combinadas con carraca reversible

Familia 0870



Referencia	art.		g
001420066	142/B6	juego de 6 llaves combinadas con carraca reversible (art. 142) en sobre 8-10-13-14-17-19 mm	800
001420069	142/B9	juego de 9 llaves combinadas con carraca reversible (art. 142) en sobre 8-10-11-12-13-14-15-17-19 mm	1.100

PUNTAS

Puntas de 1/4 para tornillos con cabeza ranurada

861LP

puntas de atornillar para tornillos con cabeza ranurada



Familia 0870



Referencia	art.	SxA mm	L mm	g
008610005	861LP 0,5X3	0,5x3	25	4,6
008610007	861LP 0,6X4	0,6x4	25	4,6
008610010	861LP 0,6X4,5	0,6x4,5	25	4,6
008610015	861LP 0,8X5,5	0,8x5,5	25	4,8
008610020	861LP 1X5,5	1x5,5	25	4,8
008610025	861LP 1,2X6,5	1,2x6,5	25	4,8
008610028	861LP 1,2X8	1,2x8	25	4,8
008610030	861LP 1,6X8	1,6x8	25	5

Puntas de 1/4 para tornillos con huella de cruz Phillips

861PH

puntas de atornillar para tornillos con huella de cruz Phillips



Familia 0870



Referencia	art.	PH	L mm	g
008610200	861PH 0	0	25	4,6
008610205	861PH 1	1	25	6
008610210	861PH 2	2	25	6
008610213	861PH 2L	2L	50	11,6
008610215	861PH 3	3	25	6
008610220	861PH 4	4	25	11,4

PUNTAS

Puntas de 1/4 para tornillos con huella de cruz Pozidriv-Supadriv

861PZ

puntas de atornillar para tornillos con huella de cruz Pozidriv®-Supadriv®



Familia 0870



Referencia	art.	PZ	L mm	g
008610300	861PZ 1	1	25	6
008610305	861PZ 2	2	25	6
008610308	861PZ 2L	2L	50	11,8
008610310	861PZ 3	3	25	5,2
008610315	861PZ 4	4	25	11,8

Puntas de 1/4 macho hexagonales

861PE

puntas macho hexagonales de atornillar



Familia 0870



Referencia	art.	mm	L mm	g
008610100	861PE 2	2	25	4,2
008610105	861PE 2,5	2,5	25	4,4
008610110	861PE 3	3	25	4,6
008610115	861PE 4	4	25	6
008610120	861PE 5	5	25	5,6
008610125	861PE 6	6	25	6,2
008610130	861PE 8	8	25	8,6
008610135	861PE 10	10	25	11,6

PUNTAS

Puntas de 1/4 para tornillos con huella Torx

861TX

puntas para tornillos con huella Torx®



Familia 0870

Referencia	art.	⊙	L mm	g
008610399	861TX 5	T5	25	4,4
008610400	861TX 6	T6	25	4,4
008610405	861TX 7	T7	25	4,4
008610410	861TX 8	T8	25	4,4
008610415	861TX 9	T9	25	4,6
008610420	861TX 10	T10	25	4,8
008610425	861TX 15	T15	25	4,8
008610430	861TX 20	T20	25	4,8
008610435	861TX 25	T25	25	5,4
008610440	861TX 27	T27	25	5,4
008610445	861TX 30	T30	25	5,6
008610450	861TX 40	T40	25	6,4



Puntas de 1/4 para tornillos con huella Torx inviolable

861RTX

puntas para tornillos con huella Tamper Resistant Torx



Familia 0870

Referencia	art.	⊙	L mm	g
008610538	861RTX 7	T7	25	4,5
008610500	861RTX 9	T9	25	4,6
008610505	861RTX 10	T10	25	4,8
008610510	861RTX 15	T15	25	4,8
008610515	861RTX 20	T20	25	4,9
008610520	861RTX 25	T25	25	5,2
008610525	861RTX 27	T27	25	5,3
008610530	861RTX 30	T30	25	5,5
008610535	861RTX 40	T40	25	5,8
008610539	861RTX 45	T45	25	5,9



PUNTAS

Puntas de 1/4 para tornillos con huella RIBE

861RIBE

Puntas de atornillar para tornillos con huella RIBE



Familia 0870

- Unión hexagonal 1/4"
- Para atornilladores manuales, eléctricos y neumáticos



Referencia	art.	⊙	L mm	g
008610705	861RIBE 5	M5	25	4,4
008610706	861RIBE 6	M6	25	4,4
008610707	861RIBE 7	M7	25	4,6
008610708	861RIBE 8	M8	25	4,6
008610709	861RIBE 9	M9	25	4,6

Puntas de 1/4 para tornillos con huella XZN

861XZN

puntas de atornillar para tornillos con huella XZN®



Familia 0870

- Unión hexagonal 1/4"
- Para atornilladores manuales, eléctricos y neumáticos



Referencia	art.	○	L mm	g
008610725	861XZN 5	M5	25	4,5
008610726	861XZN 6	M6	25	6,3
008610728	861XZN 8	M8	25	7,0

PUNTAS

Puntas de 5/16 para tornillos con cabeza ranurada

866LP

puntas de atornillar para tornillos con cabeza ranurada



Familia 0870



Referencia	art.	SxA mm	L mm	g
008660005	866LP 1X5,5	1x5,5	41	10
008660010	866LP 1,2X6,5	1,2x6,5	41	11,6
008660015	866LP 1,6X8	1,6x8	41	14
008660020	866LP 1,6X10	1,6x10	41	18
008660025	866LP 2X12	2x12	41	22

Puntas de 5/16 para tornillos con huella de cruz Phillips

866PH

puntas de atornillar para tornillos con huella de cruz Phillips®



Familia 0870



Referencia	art.	PH	L mm	g
008660200	866PH 1	1	32	9,2
008660205	866PH 2	2	32	10
008660210	866PH 3	3	32	10,2
008660215	866PH 4	4	38	16

PUNTAS

Puntas de 5/16 para tornillos con huella de cruz Pozidriv-Supadriv

866PZ

puntas de atornillar para tornillos con huella de cruz Pozidriv®-Supadriv®



Familia 0870

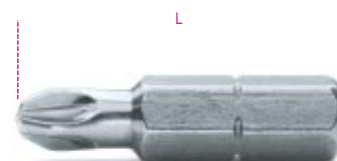

Referencia	art.	PZ	L mm	g
008660300	866PZ 1	1	32	9,2
008660305	866PZ 2	2	32	10
008660310	866PZ 3	3	32	10,2
008660315	866PZ 4	4	38	16,8

Puntas de 5/16 macho hexagonales

866PE

puntas macho hexagonales de atornillar



Familia 0870



Referencia	art.	mm	L mm	g
008660100	866PE 3	3	30	8
008660105	866PE 4	4	30	8,4
008660110	866PE 5	5	30	9,6
008660115	866PE 6	6	30	10,4
008660117	866PE 7	7	30	11,0
008660120	866PE 8	8	30	12,4
008660125	866PE 10	10	30	16,4
008660132	866PE 12	12	30	16,8
008660134	866PE 14	14	30	17,5

PUNTAS

Puntas de 5/16 para tornillos con huella Torx

866TX

puntas para tornillos con huella Torx®



Familia 0870



Referencia	art.	⊙	L mm	⚖ g
008660400	866TX 20	T20	30	9,2
008660405	866TX 25	T25	30	10,4
008660410	866TX 27	T27	30	10,4
008660415	866TX 30	T30	30	10,4
008660420	866TX 40	T40	30	10,0
008660425	866TX 45	T45	30	13,2
008660430	866TX 50	T50	30	14,0
008660435	866TX 55	T55	30	14,0
008660440	866TX 60	T60	30	14,5
008660445	866TX 70	T70	30	15,0

Puntas de 5/16 para tornillos con huella Torx Inviolable

866RTX

puntas para tornillos con huella Tamper Resistant Torx



Familia 0870



Referencia	art.	⊕	L mm	⚖ g
008660520	866RTX 40	T40	30	10,2
008660525	866RTX 45	T45	30	10,8
008660530	866RTX 50	T50	30	11,4
008660535	866RTX 55	T55	30	13,8
008660540	866RTX 60	T60	30	15,4
008660545	866RTX 70	T70	30	17,4

PUNTAS

Puntas de 10mm macho hexagonales

867PE

puntas macho hexagonales



Familia 0870



Referencia	art.	mm	L mm	g
008670104	867PE 4	4	30	13
008670105	867PE 5	5	30	13,4
008670106	867PE 6	6	30	14,4
008670107	867PE 7	7	30	15,2
008670108	867PE 8	8	30	16,6
008670110	867PE 10	10	30	19,6
008670112	867PE 12	12	30	24,4

Puntas de 10mm Larga macho hexagonales

867PE/L

puntas macho hexagonales



Familia 0870



Referencia	art.	mm	L mm	g
008670154	867PE-L 4	4	75	43
008670155	867PE-L 5	5	75	43,8
008670156	867PE-L 6	6	75	44,2
008670157	867PE-L 7	7	75	45
008670158	867PE-L 8	8	75	46,4
008670160	867PE-L 10	10	75	49,4
008670162	867PE-L 12	12	75	67,8

PUNTAS

Puntas de 10mm perfil XZN

867XZN

puntas de perfil XZN



Familia 0870

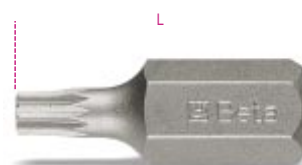

Referencia	art.	○	L mm	g
008670204	867XZN 4	M4	30	12,5
008670205	867XZN 5	M5	30	13,4
008670206	867XZN 6	M6	30	14,2
008670208	867XZN 8	M8	30	14
008670210	867XZN 10	M10	30	17,6
008670212	867XZN 12	M12	30	21,6

Puntas de 10mm Larga perfil XZN

867XZN/L

puntas con perfil XZN®



Familia 0870



Referencia	art.	○	L mm	g
008670255	867XZN-L 5	M5	75	43,2
008670256	867XZN-L 6	M6	75	44
008670258	867XZN-L 8	M8	75	45
008670260	867XZN-L 10	M10	75	47,4
008670262	867XZN-L 12	M12	75	60

PUNTAS

Puntas de 10mm para tornillos con huella Torx

867TX

puntas para tornillos con huella Torx®



Familia 0870

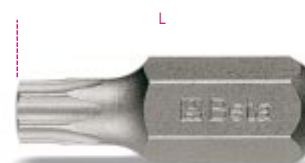

Referencia	art.	⊙	L mm	g
008670400	867TX 20	T20	30	12,6
008670405	867TX 25	T25	30	13
008670410	867TX 30	T30	30	13,6
008670415	867TX 40	T40	30	14,6
008670420	867TX 45	T45	30	15,6
008670425	867TX 50	T50	30	16,2
008670430	867TX 55	T55	30	18,4

Puntas de 10mm Larga para tornillos con huella Torx

867TX/L

puntas para tornillos con huella Torx®



Familia 0870



Referencia	art.	⊙	L mm	g
008670450	867TX-L 20	T20	75	43
008670455	867TX-L 25	T25	75	43,2
008670460	867TX-L 30	T30	75	43,4
008670465	867TX-L 40	T40	75	44,2
008670470	867TX-L 45	T45	75	45,2
008670475	867TX-L 50	T50	75	45,8
008670480	867TX-L 55	T55	75	46

PUNTAS

Puntas de 10mm para tornillos con huella Torx Inviolable

867RTX

puntas para tornillos con huella Tamper Resistant Torx®



Familia 0870

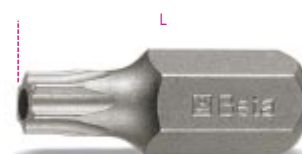

Referencia	art.	⊕	L mm	⚖ g
008670500	867RTX 20	T20	30	11
008670505	867RTX 25	T25	30	12,8
008670510	867RTX 30	T30	30	13,4
008670515	867RTX 40	T40	30	14,2
008670520	867RTX 45	T45	30	15,4
008670525	867RTX 50	T50	30	15,6
008670530	867RTX 55	T55	30	17,8

Puntas de 10mm Larga para tornillos con huella Torx Inviolable

867RTX/L

puntas para tornillos con huella Tamper Resistant Torx®



Familia 0870



Referencia	art.	⊕	L mm	⚖ g
008670550	867RTX-L 20	T20	75	42,6
008670555	867RTX-L 25	T25	75	43,2
008670560	867RTX-L 30	T30	75	43,4
008670565	867RTX-L 40	T40	75	44
008670570	867RTX-L 45	T45	75	45
008670575	867RTX-L 50	T50	75	45,6
008670580	867RTX-L 55	T55	75	47,6

PUNTAS

Puntas de 10mm perfil RIBE

867RIBE

puntas de atornillar para tornillos con huella RIBE®



Familia 0870



Referencia	art.	⌀	L mm
008670705	867RIBE	M5	30
008670706	867RIBE	M6	30
008670707	867RIBE	M7	30
008670708	867RIBE	M8	30
008670709	867RIBE	M9	30
008670710	867RIBE	M10	30
008670711	867RIBE	M11	30
008670712	867RIBE	M12	30
008670713	867RIBE	M13	30

Puntas de 10mm Larga perfil RIBE

867RIBE/L

puntas de atornillar para tornillos con huella RIBE®



Familia 0870



Referencia	art.	⌀	L mm	g
008670755	867RIBE/L	M5	75	42
008670756	867RIBE/L	M6	75	43
008670757	867RIBE/L	M7	75	44
008670758	867RIBE/L	M8	75	45
008670759	867RIBE/L	M9	75	46
008670760	867RIBE/L	M10	75	47
008670761	867RIBE/L	M11	75	49
008670762	867RIBE/L	M12	75	50
008670763	867RIBE/L	M13	75	52

ALICATES

Alicates Universales Bimaterial

1150BM

alicates universales, mangos en bimaterial



Familia 0870



Referencia	art.	L mm	L1 mm	mm	A mm	A1 mm	S mm	g
011500036	1150BM 160	160	37	1,6	24,0	6,3	11,0	200
011500038	1150BM 180	180	41	1,8	28,0	7,1	11,0	275
011500040	1150BM 200	200	45	2,0	32,0	8,0	14,0	310
011500042	1150BM 220	220	50	2,0	33,0	8,5	15,0	400

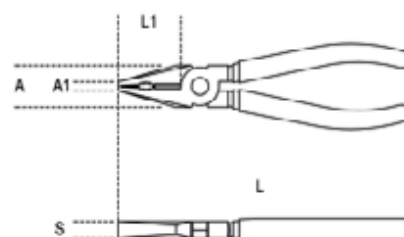

Alicate Bocas plana rectas Bimaterial

1162BM

alicates de bocas planas rectas muy largas, mangos en bimaterial



Familia 0870



Referencia	art.	L mm	L1 mm	mm	A mm	A1 mm	S mm	S1 mm	g
011620036	1162BM 160	160	58	1,6	19,0	4,0	9,0	4,5	153
011620040	1162BM 200	200	86	1,6	22,0	5,0	11,0	5,0	200

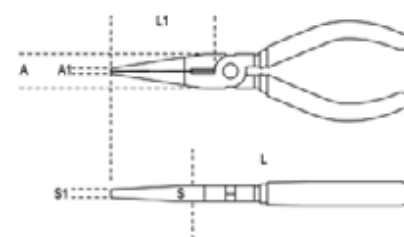

ALICATES

Alicate Bocas plana curvas Bimaterial

1164BM

alicates de bocas planas acodadas mangos en bimaterial

≡ Familia 0870



Referencia	art.	L mm	L1 mm	mm	A mm	A1 mm	S mm	S1 mm	g
011640036	1164BM 160	160	54	1,6	9,0	4,0	9,0	4,5	150
011640040	1164BM 200	200	76	1,6	22,0	5,0	11,0	5,0	190

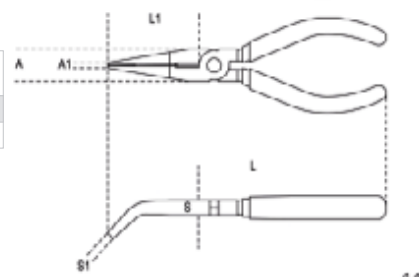

Alicate Bocas semirredondas rectas Bimaterial

1166BM

alicates de bocas semirredondas rectas con mangos en bimaterial

● Familia 0870



Referencia	art.	L mm	L1 mm	mm	A mm	A1 mm	S mm	S1 mm	g
011660036	1166BM 160	160	56	1,6	19,0	2,5	9,0	3,2	142
011660040	1166BM 200	200	76	1,6	22,0	5,0	11,0	4,0	200

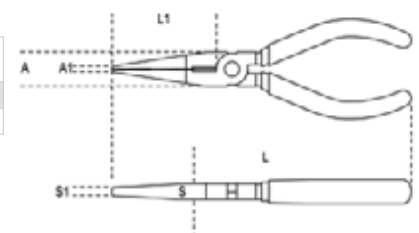

ALICATES

Alicate Bocas semirredondas curvas Bimaterial

1168BM

alicates de bocas semirredondas acodadas, mangos en bimaterial



Familia 0870

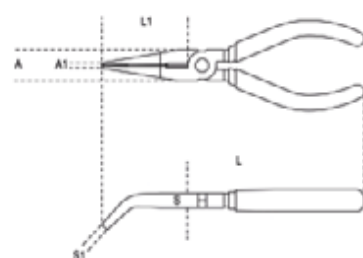

Referencia	art.	L mm	L1 mm	$\frac{A}{S}$ mm	A mm	A1 mm	S mm	S1 mm	$\frac{A}{S}$ g
011680036	1168BM 160	160	54	1,6	19,0	2,5	9,0	3,2	140
011680040	1168BM 200	200	70	1,6	22,0	5,0	11,0	4,0	210

Alicate de corte Diagonal Bimaterial

1084BM

alicates de gran efecto con cortantes diagonales, mangos en bimaterial



Familia 0870

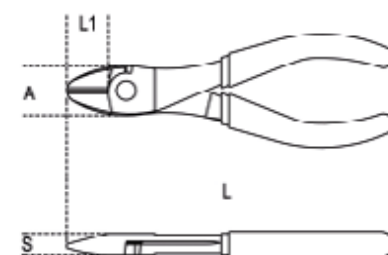

Referencia	art.	L mm	L1 mm	$\frac{A}{S}$ mm	A mm	S mm	$\frac{A}{S}$ g
010840036	1084BM 160	160	22	1,6	28,0	12,0	220
010840040	1084BM 200	200	28	2,0	36,0	16,0	380

ALICATES

Alicate multitoma regulables mango PVC

1044

alicates multitoma regulables bisagra cerrada mangos recubiertos con 2 capas de PVC antideslizante

Familia 0870

· nuevo modelo de nueve posiciones

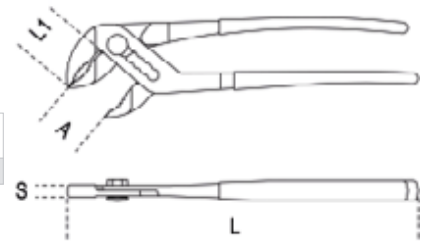

Referencia	art.	L mm	A max mm	L1 mm	S mm	g
010440250	1044 250	250	48	39	8,5	300

Tenaza Rusa mango PVC

1098PL

tenazas de ferrallista mangos recubiertos en PVC

Familia 0870



Referencia	art.	L ~	L1 mm
010980320	1098PL 220	220	13
010980350	1098PL 250	250	15
010980380	1098PL 280	280	18

ALICATES

Alicate Seeguer interior rectos mango PVC

1032

alicates para retenes interiores de bocas rectas mangos PVC



Familia 0870



Referencia	art.	L mm	∅ mm	∅1 mm	A mm	S mm	L1 mm	g
010320013	1032 140X09	140x0,9	8÷12	0,9	20	9,0	20	100
010320014	1032 140X13	140x1,3	12÷25	1,3	20	9,0	20	100
010320017	1032 180	180	19÷60	1,9	21	10,0	24	150
010320021	1032 225	225	40÷100	2,3	25	11,2	31	250
010320028	1032 300	300	85÷200	3,2	28	12,9	38	470

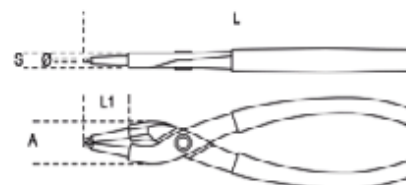

Alicate Seeguer interior curvos 90° mango PVC

1034

alicates para retenes interiores de bocas acodadas a 90° mangos PVC



Familia 0870



Referencia	art.	L mm	∅ mm	∅1 mm	A mm	S mm	L1 mm	g
010340013	1034 130X09	130x0,9	8÷12	0,9	20	9,4	12	100
010340014	1034 130X13	130x1,3	12÷25	1,3	20	9,4	12	100
010340017	1034 170	170	19÷60	1,9	21	10,0	15	150
010340021	1034 210	210	40÷100	2,3	25	11,2	22	250
010340028	1034 290	290	85÷200	3,2	28	12,9	30	470

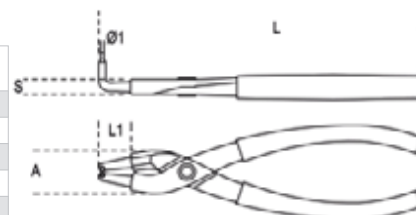

ALICATES

Alicate Seeger exterior rectos mango PVC

1036

alicates para retenes exteriores de bocas rectas mangos PVC



Familia 0870



Referencia	art.	L mm	● Ø mm	Ø1 mm	A mm	S mm	L1 mm	g
010360013	1036 140X09	140x0,9	3÷10	0,9	20	9,4	20	100
010360014	1036 140X13	140x1,3	10÷25	1,3	20	9,0	20	100
010360017	1036 175	175	19÷60	1,9	21	10,0	25	160
010360021	1036 225	225	40÷100	2,3	25	11,2	11	250
010360028	1036 300	300	85÷200	3,2	34	12,9	40	500

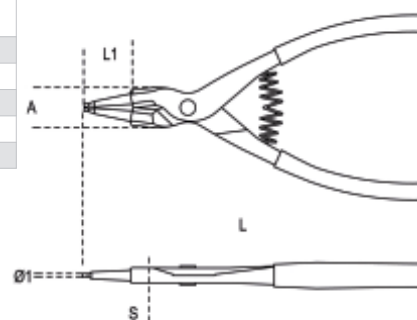

Alicate Seeger exterior curvos 90° mango PVC

1038

alicates para retenes exteriores de bocas acodadas a 90° mangos PVC



Familia 0870



Referencia	art.	L mm	● Ø mm	Ø1 mm	A mm	S mm	L1 mm	g
010380013	1038 135X09	135x0,9	3÷10	0,9	20	9,4	12	100
010380014	1038 135X13	135x1,3	10÷25	1,3	20	9,4	12	100
010380017	1038 175	175	19÷60	-	21	10,0	23	160
010380021	1038 220	220	40÷100	-	25	11,2	23	250
010380028	1038 300	300	85÷200	-	35	13,0	38	500

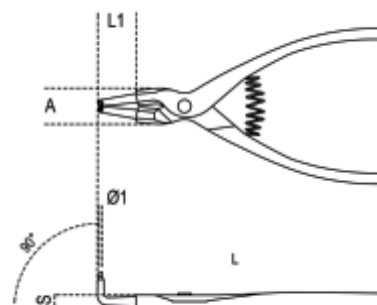

ALICATES

Juego Alicates Seeguer interior y exterior

1031/S4

juego de 4 alicates para retenes interiores y exteriores

Familia 0870

 650 g



Referencia	art.	
010310000	1031/S4	1032 interiores bocas rectas 180  19 ÷ 60 mm 1034 interiores bocas curvas 170  19 ÷ 60 mm 1036 exteriores bocas rectas 175  19 ÷ 60 mm 1038 exteriores bocas curvas 175  19 ÷ 60 mm

MORDAZAS

Mordaza de presión

1052

mordazas de presión, mordazas cóncavas

Familia 0870



Referencia	art.	L mm	A mm	A1 max mm	S mm	g
010520014	1052 140	140	48	22	6,0	175
010520019	1052 190	190	60	36	9,0	360
010520024	1052 240	240	72	42	10,0	590
010520030	1052 300	300	75	55	12,0	900

Mordaza de presión rectas

1054

mordaza de presión, mordazas rectas

Familia 0870

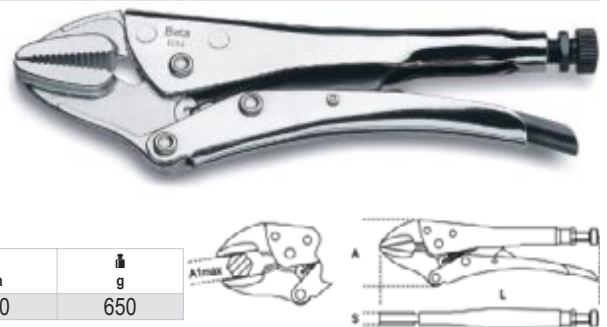

Referencia	art.	L mm	A max mm	A mm	S mm	g
010540022	1054	235	40	70,0	16,0	650

MORDAZAS

Mordaza de presión bocas largas

1058

mordazas de presión, bocas largas

Familia 0870

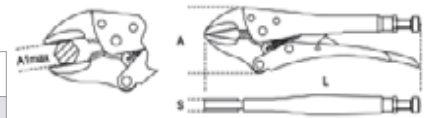

Referencia	art.	L mm	A1 max mm	Ø max mm	A mm	S mm	g
010580018	1058 180	180	35	22	48	4,5	180
010580024	1058 240	240	50	35	64	5,0	370
010580031	1058 310	310	65	40	65,0	6,0	440

Mordaza de presión cuello cisne

1062

mordazas de presión tramos largos, mordazas de cuello de cisne

Familia 0870

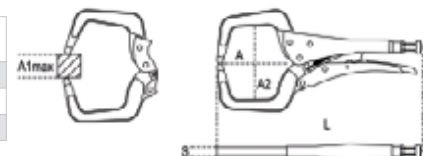

Referencia	art.	L mm	A1 max mm	A mm	A2 mm	S mm	g
010620017	1062 170	170	50	45,0	60	5,0	235
010620029	1062 290	290	120	75,0	95	12,0	885
010620046	1062 460	460	250	250	95	12	1380

MORDAZAS

Mordaza de presión de horquilla

1060

mordazas de presión para angulares, mordazas de horquilla

Familia 0870



Referencia	art.	L mm	A mm	A1 max mm	A2 mm	A3 mm	g
010600020	1060 200	200	70	50	57	68	700
010600028	1060 280	280	70	80	43	90	930

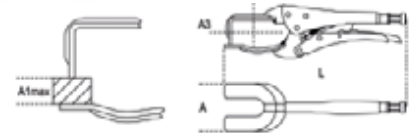

MARTILLOS

Martillo mecánico cabeza esférica

1377

martillos de cabeza redonda y boca esférica para caldereros y hojalateros mango en madera

Familia 0870

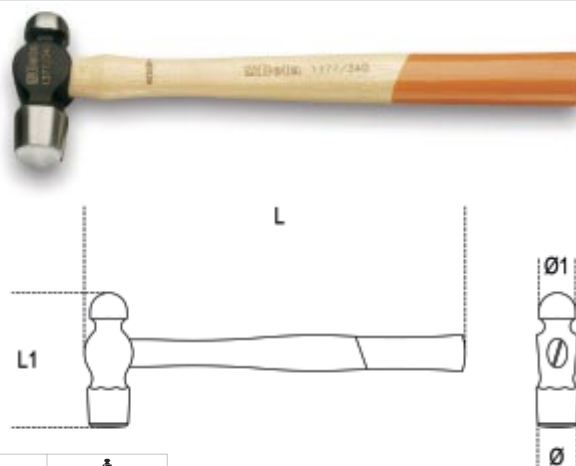

Referencia	art.	g	Ø mm	Ø1 mm	L mm	L1 mm	g
013770134	1377 340	340	27	23	330	95	422
013770145	1377 450	450	29	25	350	102	663
013770157	1377 570	570	32	28	350	110	690
013770168	1377 680	680	34	29	360	116	887
013770190	1377 900	900	40	30	380	120	1224

Referencia	Descripción
013770234	Recambio mango martillo 340 grs.
013770245	Recambio mango martillo 450 grs.
013770257	Recambio mango martillo 570 grs.
013770268	Recambio mango martillo 680 grs.
013770290	Recambio mango martillo 900 grs.

MARTILLOS

Martillo mecánico tipo alemán

1370

martillos de mecánico tipo alemán mango en madera

Familia 0870



HICKORY

Referencia	art.	g	A mm	L mm	L1 mm		g
013700051	1370 100	100	15	260	82	1370/MR100	147
013700052	1370 200	200	19	280	95	1370/MR200	236
013700053	1370 300	300	23	300	105	1370/MR300	439
013700054	1370 400	400	25	310	112	1370/MR400	535
013700055	1370 500	500	27	320	118	1370/MR500	669
013700056	1370 600	600	30	330	122	1370/MR600	745
013700058	1370 800	800	33	350	130	1370/MR800	949
013700060	1370 1000	1000	36	360	135	1370/MR1000	1180
013700065	1370 1500	1500	42	380	145	1370/MR1500	1722
013700070	1370 2000	2000	47	400	155	1370/MR2000	2181

Referencia	Descripción
013700081	Recambio mango martillo 100 grs.
013700082	Recambio mango martillo 200 grs.
013700083	Recambio mango martillo 300 grs.
013700084	Recambio mango martillo 400 grs.
013700085	Recambio mango martillo 500 grs.
013700086	Recambio mango martillo 600 grs.
013700088	Recambio mango martillo 800 grs.
013700090	Recambio mango martillo 1000 grs.
013700095	Recambio mango martillo 1500 grs.
013700100	Recambio mango martillo 2000 grs.

MARTILLOS

Martillo mecánico tipo francés

1370F

martillos de mecánico tipo francés mango en madera

Familia 0870



Referencia	art.	A mm	B mm	L mm	L1 mm		g
013700424	1370F 24	24	19	260	77	1370F/MR24	280
013700426	1370F 26	26	21	260	80	1370F/MR24	310
013700428	1370F 28	28	22	280	86	1370F/MR28	400
013700430	1370F 30	30	24	280	92	1370F/MR28	450
013700432	1370F 32	32	26	300	100	1370F/MR32	550
013700436	1370F 36	36	29	300	104	1370F/MR32	720
013700440	1370F 40	40	33	330	110	1370F/MR40	1065
013700442	1370F 42	42	34	330	116	1370F/MR40	1080
013700450	1370F 50	50	40	380	138	1370F/MR50	1760
013700460	1370F 60	60	42	380	160	1370F/MR60	2585

Referencia	Descripción
013700474	Recambio mango martillo
013700478	Recambio mango martillo
013700482	Recambio mango martillo
013700490	Recambio mango martillo
013700495	Recambio mango martillo
013700496	Recambio mango martillo

MARTILLOS

Mazas antirrebote

1391

mazas antirrebote completamente forradas de caucho

Familia 0870



Referencia	art.	Ø mm	L mm	L1 mm	g
013910135	1391 35	35	280	90	444
013910150	1391 50	50	320	105	913
013910155	1391 55	55	355	110	1012
013910165	1391 65	65	380	130	1435

Martillo con cabezas nailon intercambiables

1390N

mazos de cabezas intercambiables en nailon, mango en madera

Familia 0870

Cabezas medio-duras: 75 Shore
Resistentes al aceite y al desgaste
Especialmente indicados para trabajar en chapa y metales



Referencia	art.	Ø mm	L mm	L1 mm
013900522	1390N 22	22	260	70
013900528	1390N 28	28	280	85
013900535	1390N 35	35	310	95
013900545	1390N 45	45	320	107
013900560	1390N 60	60	380	128

Referencia	Descripción
013900222	Recambio mango martillo 22 grs.
013900228	Recambio mango martillo 28 grs.
013900235	Recambio mango martillo 35 grs.
013900245	Recambio mango martillo 45 grs.
013900260	Recambio mango martillo 60 grs.

MARTILLOS

Macetas mango madera

1380

macetas mango en madera

Familia 0870



Referencia	art.	g	A mm	L mm	L1 mm		g
013800208	1380 800	800	38	260	90	1380/MR800	980
013800210	1380 1000	1000	40	260	95	1380/MR800	1090
013800212	1380 1250	1250	43	260	100	1380/MR800	1380
013800215	1380 1500	1500	45	280	110	1380/MR1500	1635
013800220	1380 2000	2000	50	300	120	1380/MR2000	2321

Referencia	Descripción
013800238	Recambio mango martillo 800-1000-1250 grs.
013800245	Recambio mango martillo 1500 grs.
013800250	Recambio mango martillo 2000 grs.

Mazas rectas mango madera

1381

mazas rectas mango en madera hickory

Familia 0870



Referencia	art.	g	A mm	L mm	L1 mm		Kg
013810030	1381 3000	3000	55	800	142	1381/MR3-4	3,52
013810040	1381 4000	4000	60	900	152	1381/MR3-4	4,6
013810050	1381 5000	5000	70	900	162	1381/MR5	5,65
013810080	1381 8000	8000*	80	900	185	1381/MR8	8,5

Referencia	Descripción
013810730	Recambio mango martillo 3000-4000 grs.
013810750	Recambio mango martillo 5000 grs.
013810780	Recambio mango martillo 8000 grs.

MARTILLOS

Martillo de aplanar cabeza convexa mango de madera

1345

martillo de aplanar cabeza convexa mango de madera

Familia 0870



Descripción	Referencia	art.
Martillo de aplanar cabeza convexa mango de madera	013450010	1345

Referencia	Descripción
013700084	Recambio mango martillo

Martillo de aplanar cabeza plana y peña esférica mango de madera

1351

martillo de aplanar cabeza plana y peña esférica mango de madera

Familia 0870



Descripción	Referencia	art.
Martillo de aplanar cabeza plana y peña esférica mango de madera	013510010	1351

Referencia	Descripción
013700084	Recambio mango martillo

MARTILLOS

Martillo de aplanar cabeza plana y peña en punta mango de madera

1353

martillo de aplanar cabeza plana y peña en punta mango de madera

Familia 0870



Descripción	Referencia	art.
Martillo de aplanar cabeza plana y peña en punta mango de madera	013530010	1353

Referencia	Descripción
013700084	Recambio mango martillo

Martillos postillón cabeza plana moleteada y cuadrada lisa mango de madera

1357Z/45

martillos postillon cabeza plana moleteada y cuadrada lisa mango de madera

Familia 0870



Descripción	Referencia	art.
Martillos postillón cabeza plana moleteada y cuadrada lisa mango de madera	013570045	1357Z/45

Referencia	Descripción
013700082	Recambio mango martillo

MARTILLOS

Martillo de peña horizontal y cabeza plana mango de madera

1359T

martillo de peña horizontal y cabeza plana mango de madera

Familia 0870



Descripción	Referencia	art.
Martillo de peña horizontal y cabeza plana mango de madera	013590010	1359 T

Referencia	Descripción
013700084	Recambio mango martillo

BOTADORES

Botadores cónicos

30

botadores cónicos

Familia 0870

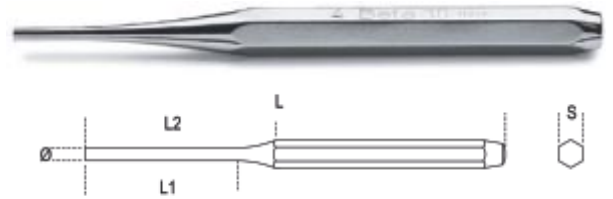

Referencia	art.	Ø mm	L mm	L1 mm	L2 mm	S mm	ñ g
000300020	30 2	2	125	6	54	10	58
000300030	30 3	3	125	8	54	10	59
000300040	30 4	4	150	11	60	12	105
000300050	30 5	5	150	15	61	12	106
000300060	30 6	6	150	20	64	12	107

Botadores cilíndricos

31

botadores cilíndricos

Familia 0870

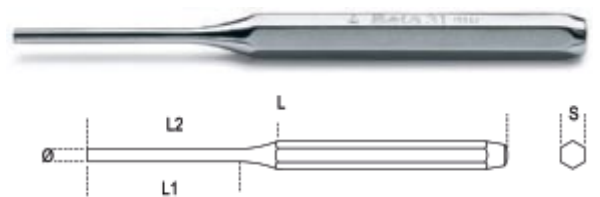

Referencia	art.	Ø mm	L mm	L1 mm	L2 mm	S mm	ñ g
000310002	31 2	2	110	22	40	8	33
000310003	31 3	3	128	35	52	8	37
000310004	31 4	4	146	45	64	10	63
000310005	31 5	5	164	55	73	10	75
000310006	31 6	6	182	65	84	12	115
000310008	31 8	8	200	80	97	12	135
000310010	31 10	10	220	95	115	14	205

BOTADORES

Juego 6 botadores cilíndricos en bolsa

31_serie

juego 6 botadores cilíndricos en bolsa

Familia 0870

Referencia	art.		g
000310020	31/B6	juego de 6 botadores cilíndricos (art. 31) en sobre	509
000310030	31/SP6	juego de 6 botadores cilíndricos (art. 31) con soporte	706



Botadores cilíndrico con mango

31BM

botadores cilíndricos con mango

Familia 0870

- Absorción de los choques
- Mango seguro
- Protección de la mano



Referencia	art.	Ø mm	L mm	L1 mm	g
000310402	31BM 2	2	168	42	73
000310403	31BM 3	3	180	52	75
000310404	31BM 4	4	191	62	106
000310405	31BM 5	5	200	72	110
000310406	31BM 6	6	221	82	174
000310408	31BM 8	8	235	94	194

CORTAFRÍOS

Cortafríos plano

34

cortafríos planos

Familia 0870

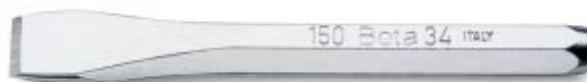

Referencia	art.	L mm	A mm	L1 mm	S mm	g
000340001	34 125	125	14,5	45	10	77
000340002	34 150	150	17,0	58	12	134
000340003	34 175	175	21,5	68	14	213



TIJERAS

Tijeras electricista hojas rectas

1128BM

tijeras de electricista, hojas rectas

Familia 0870



Referencia	art.	L mm	L1 mm	A mm	B mm	g
011280000	1128BM	145	50	17	9	103

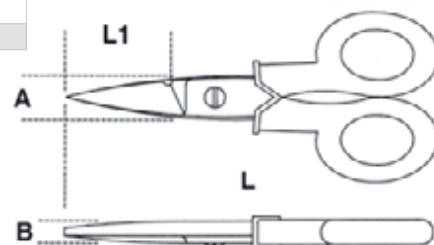

LIMAS

Lima cuadrada corte semi con mango

1719BMA...Q

limas cuadradas de corte semidulce, con mango

Familia 0870



Referencia	art.	L mm	L "	W g
017190021	1719BMA6/Q	150	6	84
017190052	1719BMA8/Q	200	8	140
017190071	1719BMA10/Q	250	10	252
017190311	1719BMA12/Q	300	12	389

Lima triangular corte semi con mango

1719BMA...T

limas triangulares de corte semidulce, con mango

Familia 0870



Referencia	art.	L mm	L "	W g
017190023	1719BMA6/T	150	6	140
017190054	1719BMA8/T	200	8	210
017190073	1719BMA10/T	250	10	362
017190313	1719BMA12/T	300	12	550

LIMAS

Lima plana corte semi con mango

1719BMA...P

limas planas de corte semidulce, con mango

Familia 0870



Referencia	art.	L mm	L "	g
017190025	1719BMA6/P	150	6	129
017190056	1719BMA8/P	200	8	221
017190075	1719BMA10/P	250	10	373
017190315	1719BMA12/P	300	12	531

Lima semirredonda corte semi con mango

1719BMA...M

limas semirredondas de corte semidulce, con mango

Familia 0870



Referencia	art.	L mm	L "	g
017190027	1719BMA6/M	150	6	130
017190058	1719BMA8/M	200	8	166
017190077	1719BMA10/M	250	10	322
017190317	1719BMA12/M	300	12	514

LIMAS

Lima redonda corte semi con mango

1719BMA...R

limas redondas de corte semidulce, con mango

Familia 0870



Referencia	art.	L mm	L "	g
017190029	1719BMA6/R	150	6	80
017190060	1719BMA8/R	200	8	105
017190079	1719BMA10/R	250	10	219
017190319	1719BMA12/R	300	12	318

Juego limas de aguja en bolsa de plástico

1720/B

juego de limas aguja en bolsa de plástico

Familia 0870



Referencia	art.		g
017200002	1720/B6	juego de 6 limas aguja (art. 1720/...) en sobre	65
017200003	1720/B12	juego de 12 limas aguja (art. 1720/...) en sobre	130

ÚTILES

Juego de galgas para espesores

1708/...

galgas de espesores

Familia 0870

Juegos 8, 13 y 20 lamas respectivamente



Referencia	art.	medidas	S mm	S "	L mm	g
017080008	1708/8	S = 0,05±0,50 mm	0,05±0,5	0,002±0,020	105	35
017080013	1708/13	S = 0,05±1,00 mm	0,05±1,0	0,002±0,035	105	65
017080020	1708/20	S = 0,05±1,00 mm	0,05±1,0	0,002±0,040	105	100

Juegos extractores cónicos para tornillos

1430/S

juegos extractores cónicos para tornillos

Familia 0870

Referencia	art.		g
014300105	1430/S5	juego de 5 extractores cónicos M3-M18 para tornillos rotos	133
014300106	1430/S6	juego de 6 extractores cónicos M3-M24 para tornillos rotos	248
014300108	1430/S8	juego de 8 extractores cónicos M3-M50 para tornillos rotos	745



• despiece

Referencia	art.	M	A mm	D mm	D1 mm	L mm	□ mm	g
014300006	1430/1	3÷6	2,5	2,2	3,8	50	3,0	5
014300008	1430/2	6÷8	3,0	3,0	4,8	50	4,0	8
014300011	1430/3	8÷11	4,5	3,3	6,4	63	5,0	14
014300014	1430/4	11÷14	6,0	4,7	8,4	75	6,3	26
014300018	1430/5	14÷18	8,0	6,3	10,9	85	8,8	49
014300024	1430/6	18÷24	11,0	9,5	14,9	95	11,7	104
014300033	1430/7	24÷33	14,0	12,7	18,9	95	14,8	178
014300050	1430/8	33÷50	21,0	19,0	24,9	100	20,0	344

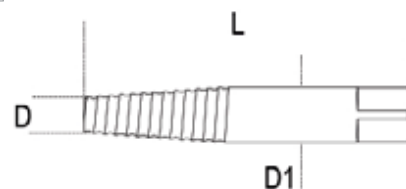
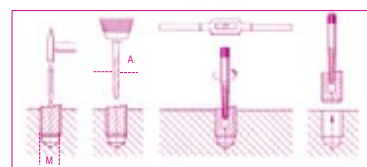

ÚTILES

Llaves de correa para filtros de aceite

1490

llaves de correa para filtros de aceite

Familia 0870

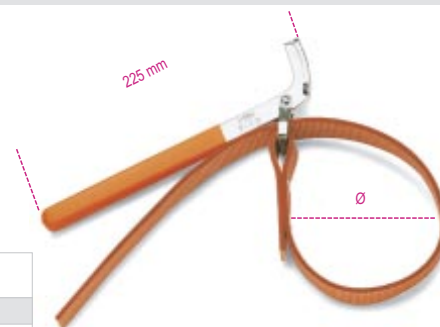

Referencia	art.	Ø max mm	g
014900001	1490/1	160	290
014900002	1490/2	240	310

Llave de correa metálica regulable para filtros de aceite

1491

llave de correa metálica regulable para filtros de aceite

Familia 0870



Referencia	art.	Ø mm	g
014910001	1491	65÷110	450
0833 300 161	Recambio fleje	65-110	

ÚTILES

Juego de 3 alicates de plástico para oclusión de tubos y manguitos

1481PL/S3

juego de 3 alicates de plástico para oclusión de tubos y manguitos

Familia 0870

Referencia	art.		g
014810200	1481PL/S3	juego de 3 alicates de plástico para oclusión de tubos y manguitos	240

• despiece

Referencia	art.	Ø mm	g
014810110	1481PL/A	8÷15	45
014810120	1481PL/B	15÷25	75
014810130	1481PL/C	25÷45	130



Extractores de muelles amortiguadores

1556/1A

extractores de muelles amortiguadores

Familia 0870

Referencia	art.	min L Max mm	kg
015560101	1556/1A	65÷320	2,8



ÚTILES

Tenaza para equilibrado ruedas

989

tenaza para equilibrado ruedas

Familia 0870



Referencia	art.	L mm	g
009890001	989	250	320

Juego de 4 cortafríos de plástico para retirar plomos adhesivos

988/K4

juego de 4 cortafríos de plástico anti-rayas

Familia 0870

- Especialmente indicados para retirar los plomos adhesivos de las llantas de aleación
- Cortantes en 3 lados para un uso más versátil



Referencia	art.	A mm	g
009880104	988/K4	A= 19-21-25-38 mm	550



ÚTILES

Palanca para válvulas neumáticas, con desmontaválvulas en el mango

987P

palanca para válvulas neumáticos en material plástico

Familia 0870

En el mango está incluido el destornillador para maniobrar el mecanismo dentro de la válvula

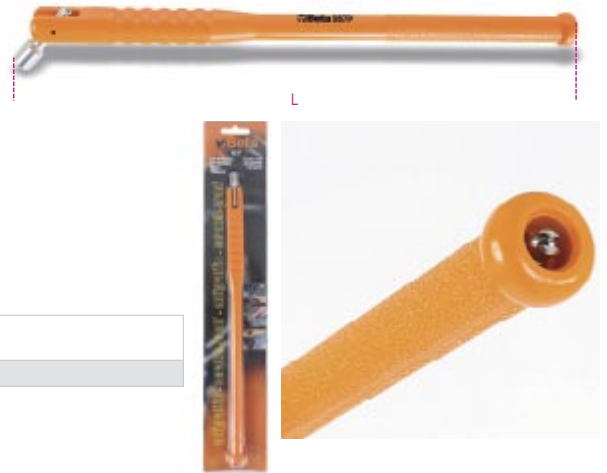

Referencia	art.	L mm
009870011	987P	335

Destornillador para válvulas neumáticas

986 78

destornillador para válvulas neumáticos

Familia 0870



Referencia	art.	L mm	L1 mm	g
009860078	986 78	18	78	32



ÚTILES

Desmontadores de neumáticos

962

desmontadores de neumáticos

Familia 0870



Referencia	art.	L mm	A mm	g
009620003	962 300	300	21	300
009620004	962 400	400	25	450
009620005	962 500	500	27	750
009620006	962 600	600	27	1

Portalima con lima de dentado radial, plana y flexible

1338A - 1338B

portalima con lima de dentado radial, plana y flexible

Familia 0870

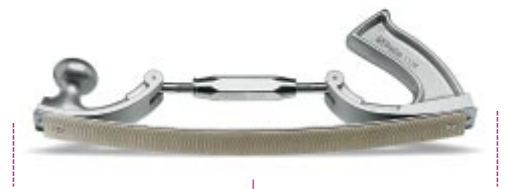

Referencia	art.	1"	L mm	g
013380001	1338A	Grano grueso	360	890
013380002	1338B	Grano fino	360	920

Referencia	Descripción
013380004	Recambio lima gruesa
013380005	Recambio lima medio

ÚTILES

Extractor de grapas

1479

extractor de orejuelas

Familia 0870

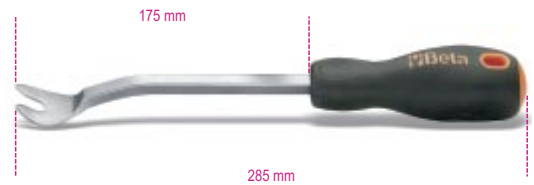

Referencia	art.	g
014790001	1479	160

Rascador multiuso con mango en bimaterial

1774A

rascador multiuso con mango en bimaterial

Familia 0870



Referencia	art.	L mm	A mm
017740011	1774A	300	40

Referencia	Descripción
017740511	Hojas para rascador

ÚTILES

Extractores magnéticos flexibles

1712E/...

extractores magnéticos flexibles

Familia 0870

F = fuerza magnética

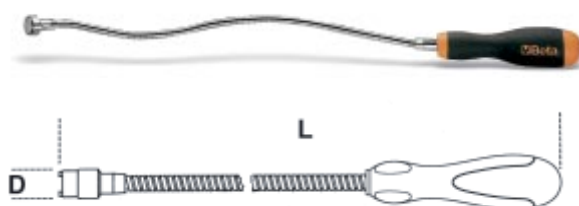

Referencia	art.	L mm	D mm	F kg	g
017120011	1712E/1	420	7,5	0,5	145
017120012	1712E/2	530	15	1,8	232
017120013	1712E/3	532	19	3,0	239

Punta angulada para usos genéricos

1716A

punta angulada para usos genéricos

Familia 0870

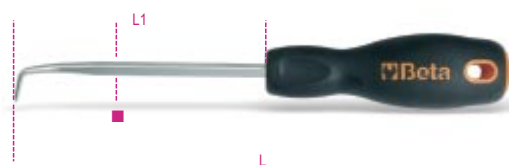

Referencia	art.	L mm	L1 mm	■ mm	g
017160040	1716A	240	125	6	105

ÚTILES

Puntero de punta cuadrada

1716Q

puntero de punta cuadrada

Familia 0870

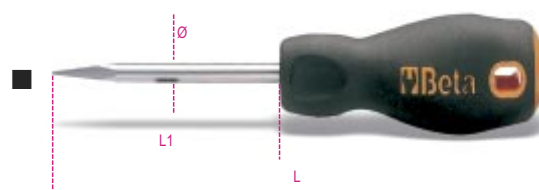

Referencia	art.	L mm	L1 mm	D mm	g
017160010	1716Q	215	100	6	78

Puntero de punta redonda

1716R

puntero de punta redonda

Familia 0870



Referencia	art.	L mm	L1 mm	D mm	g
017160001	1716R	215	100	6	78

ÚTILES

Punta de garfio para usos genéricos

1716U

punta de garfio para usos genéricos

Familia 0870

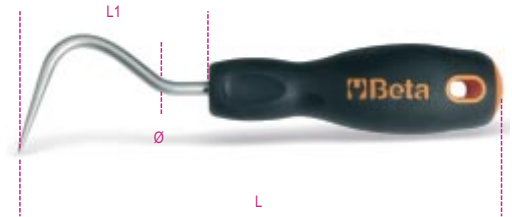

Referencia	art.	L mm	L1 mm	D mm	g
017160025	1716U	195	80	6	92

Alfombra de protección para rodillas

2254T

Alfombra de protección para rodillas

Familia 0870

Realizada en EVA antideslizante



Descripción	Referencia	art.
Alfombra de protección para rodillas 470x290x30 mm	022540047	2254T





VASO 1/4" PUNTA PLANA

Descripción	Referencia	U/E
Vaso 1/4" Punta Plana 3 mm	0850 071 403	1
Vaso 1/4" Punta Plana 3,5 mm	0850 071 435	1
Vaso 1/4" Punta Plana 4 mm	0850 071 404	1
Vaso 1/4" Punta Plana 5 mm	0850 071 405	1
Vaso 1/4" Punta Plana 6 mm	0850 071 406	1
Vaso 1/4" Punta Plana 7 mm	0850 071 407	1
Vaso 1/4" Punta Plana 8 mm	0850 071 408	1



VASO 1/4" PUNTA PHILLIPS

Descripción	Referencia	U/E
Vaso 1/4" Punta Phillips PH0	0850 071 500	1
Vaso 1/4" Punta Phillips PH1	0850 071 501	1
Vaso 1/4" Punta Phillips PH2	0850 071 502	1
Vaso 1/4" Punta Phillips PH3	0850 071 503	1
Vaso 1/4" Punta Phillips PH4	0850 071 504	1



VASO 1/4" PUNTA HEXAGONAL

Descripción	Referencia	U/E
Vaso 1/4" Punta Hexagonal 3 mm	0850 071 103	1
Vaso 1/4" Punta Hexagonal 4 mm	0850 071 104	1
Vaso 1/4" Punta Hexagonal 5 mm	0850 071 105	1
Vaso 1/4" Punta Hexagonal 6 mm	0850 071 106	1
Vaso 1/4" Punta Hexagonal 7 mm	0850 071 107	1
Vaso 1/4" Punta Hexagonal 8 mm	0850 071 108	1





VASO 1/4" PUNTA TORX

Descripción	Referencia	U/E
Vaso 1/4" Punta Torx T8	0850 071 208	1
Vaso 1/4" Punta Torx T10	0850 071 210	1
Vaso 1/4" Punta Torx T15	0850 071 215	1
Vaso 1/4" Punta Torx T20	0850 071 220	1
Vaso 1/4" Punta Torx T25	0850 071 225	1
Vaso 1/4" Punta Torx T27	0850 071 227	1
Vaso 1/4" Punta Torx T30	0850 071 230	1
Vaso 1/4" Punta Torx T40	0850 071 240	1



VASO 1/4" PUNTA TORX INVIOLEBLE

Descripción	Referencia	U/E
Vaso 1/4" Punta Torx Inviolable T8	0850 071 308	1
Vaso 1/4" Punta Torx Inviolable T10	0850 071 310	1
Vaso 1/4" Punta Torx Inviolable T15	0850 071 315	1
Vaso 1/4" Punta Torx Inviolable T20	0850 071 320	1
Vaso 1/4" Punta Torx Inviolable T25	0850 071 325	1
Vaso 1/4" Punta Torx Inviolable T27	0850 071 327	1
Vaso 1/4" Punta Torx Inviolable T30	0850 071 330	1





VASO 1/2" PUNTA HEXAGONAL CORTA

Descripción	Referencia	U/E
Vaso 1/2" Punta Hexagonal 5 mm L55	0850 724 505	1
Vaso 1/2" Punta Hexagonal 6 mm L55	0850 724 506	1
Vaso 1/2" Punta Hexagonal 7 mm L55	0850 724 507	1
Vaso 1/2" Punta Hexagonal 8 mm L55	0850 724 508	1
Vaso 1/2" Punta Hexagonal 9 mm L55	0850 724 509	1
Vaso 1/2" Punta Hexagonal 10 mm L55	0850 724 510	1
Vaso 1/2" Punta Hexagonal 12 mm L55	0850 724 512	1
Vaso 1/2" Punta Hexagonal 14 mm L55	0850 724 514	1
Vaso 1/2" Punta Hexagonal 17 mm L70	0850 724 017	1
Vaso 1/2" Punta Hexagonal 19 mm L70	0850 724 019	1



VASO 1/2" PUNTA HEXAGONAL LARGA

Descripción	Referencia	U/E
Vaso 1/2" Punta Hexagonal 5 mm L100	0850 724 005	1
Vaso 1/2" Punta Hexagonal 6 mm L100	0850 724 006	1
Vaso 1/2" Punta Hexagonal 7 mm L100	0850 724 007	1
Vaso 1/2" Punta Hexagonal 8 mm L100	0850 724 008	1
Vaso 1/2" Punta Hexagonal 10 mm L100	0850 724 010	1
Vaso 1/2" Punta Hexagonal 12 mm L100	0850 724 012	1



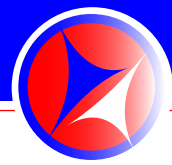

VASO 1/2" PUNTA TORX CORTA

Descripción	Referencia	U/E
Vaso 1/2" Punta Torx T20 L55	0850 725 520	1
Vaso 1/2" Punta Torx T25 L55	0850 725 525	1
Vaso 1/2" Punta Torx T27 L55	0850 725 527	1
Vaso 1/2" Punta Torx T30 L55	0850 725 530	1
Vaso 1/2" Punta Torx T40 L55	0850 725 540	1
Vaso 1/2" Punta Torx T45 L55	0850 725 545	1
Vaso 1/2" Punta Torx T47 L55	0850 725 547	1
Vaso 1/2" Punta Torx T50 L55	0850 725 550	1
Vaso 1/2" Punta Torx T55 L55	0850 725 555	1
Vaso 1/2" Punta Torx T60 L55	0850 725 560	1
Vaso 1/2" Punta Torx T70 L55	0850 725 570	1
Vaso 1/2" Punta Torx T80 L55	0850 725 580	1

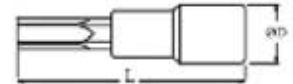
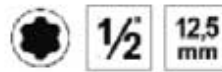

VASO 1/2" PUNTA TORX LARGA

Descripción	Referencia	U/E
Vaso 1/2" Punta Torx T20 L100	0850 721 020	1
Vaso 1/2" Punta Torx T25 L100	0850 721 025	1
Vaso 1/2" Punta Torx T27 L100	0850 721 027	1
Vaso 1/2" Punta Torx T30 L100	0850 721 030	1
Vaso 1/2" Punta Torx T40 L100	0850 721 040	1
Vaso 1/2" Punta Torx T45 L100	0850 721 045	1
Vaso 1/2" Punta Torx T50 L100	0850 721 050	1
Vaso 1/2" Punta Torx T55 L100	0850 721 055	1
Vaso 1/2" Punta Torx T60 L100	0850 721 060	1
Vaso 1/2" Punta Torx T70 L100	0850 721 070	1
Vaso 1/2" Punta Torx T80 L100	0850 721 080	1
Vaso 1/2" Punta Torx T90 L100	0850 721 090	1
Vaso 1/2" Punta Torx T100 L100	0850 721 100	1

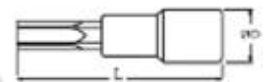
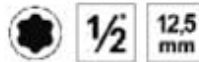



VASO 1/2" PUNTA TORX INVIOBLE

Descripción	Referencia	U/E
Vaso 1/2" Punta Torx Inviolable T20 L55	0850 726 520	1
Vaso 1/2" Punta Torx Inviolable T25 L55	0850 726 525	1
Vaso 1/2" Punta Torx Inviolable T27 L55	0850 726 527	1
Vaso 1/2" Punta Torx Inviolable T30 L55	0850 726 530	1
Vaso 1/2" Punta Torx Inviolable T40 L55	0850 726 540	1
Vaso 1/2" Punta Torx Inviolable T45 L55	0850 726 545	1
Vaso 1/2" Punta Torx Inviolable T50 L55	0850 726 550	1
Vaso 1/2" Punta Torx Inviolable T55 L55	0850 726 555	1
Vaso 1/2" Punta Torx Inviolable T60 L55	0850 726 560	1
Vaso 1/2" Punta Torx Inviolable T70 L55	0850 726 570	1
Vaso 1/2" Punta Torx Inviolable T80 L70	0850 726 580	1



VASO 1/2" PUNTA XZN CORTA

Descripción	Referencia	U/E
Vaso 1/2" Punta XZN M5 L55	0850 728 505	1
Vaso 1/2" Punta XZN M6 L55	0850 728 506	1
Vaso 1/2" Punta XZN M8 L55	0850 728 508	1
Vaso 1/2" Punta XZN M10 L55	0850 728 510	1
Vaso 1/2" Punta XZN M12 L55	0850 728 512	1
Vaso 1/2" Punta XZN M14 L55	0850 728 514	1
Vaso 1/2" Punta XZN M16 L55	0850 728 516	1



VASO 1/2" PUNTA XZN LARGA

Descripción	Referencia	U/E
Vaso 1/2" Punta XZN M5 L100	0850 728 005	1
Vaso 1/2" Punta XZN M6 L100	0850 728 006	1
Vaso 1/2" Punta XZN M8 L100	0850 728 008	1
Vaso 1/2" Punta XZN M10 L100	0850 728 010	1
Vaso 1/2" Punta XZN M12 L100	0850 728 012	1
Vaso 1/2" Punta XZN M14 L100	0850 728 014	1
Vaso 1/2" Punta XZN M16 L100	0850 728 016	1

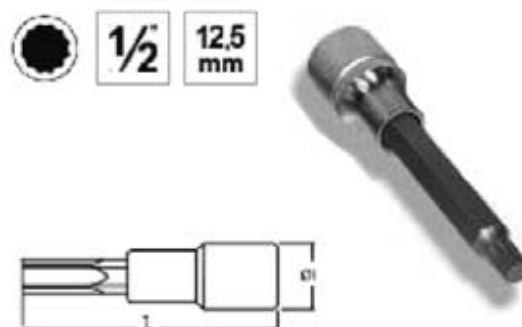



VASO 1/2" PUNTA RIBE CORTO

Descripción	Referencia	U/E
Vaso 1/2" Punta RIBE M5 L63	0850 724 305	1
Vaso 1/2" Punta RIBE M6 L63	0850 724 306	1
Vaso 1/2" Punta RIBE M8 L63	0850 724 308	1
Vaso 1/2" Punta RIBE M10 L63	0850 724 310	1
Vaso 1/2" Punta RIBE M12 L63	0850 724 312	1
Vaso 1/2" Punta RIBE M14 L63	0850 724 314	1

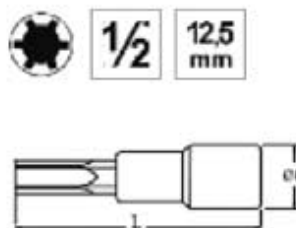

VASO 1/2" PUNTA XZN LARGO

Descripción	Referencia	U/E
Vaso 1/2" Punta RIBE M5 L100	0850 724 105	1
Vaso 1/2" Punta RIBE M6 L100	0850 724 106	1
Vaso 1/2" Punta RIBE M8 L100	0850 724 108	1
Vaso 1/2" Punta RIBE M10 L100	0850 724 110	1
Vaso 1/2" Punta RIBE M12 L100	0850 724 112	1
Vaso 1/2" Punta RIBE M14 L100	0850 724 114	1

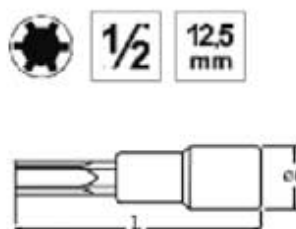

Llave Rápida con Carraca de 13 a 30 mm

Descripción	Referencia	U/E
1 Llave Rápida con Carraca de 13 a 30 mm	0850 821 030	1

- Llave Rápida con Carraca que permite apretar y soltar tuercas. Reversible.

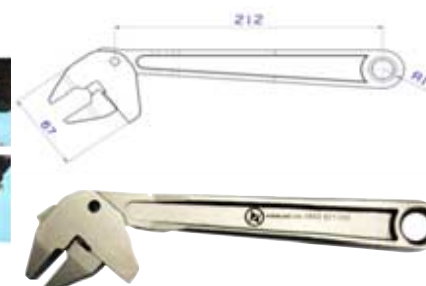

Multiplicador de Torsión

Descripción	Referencia	U/E
Multiplicador 1/2" int. 3/4" ext., par máx. 1300, 5:01 multiplicación	0845 616 804	1
Multiplicador 3/4" int. 1" ext., par máx. 2700, 5:01 multiplicación	0845 616 805	1





Juego de 8 Destornilladores de Precision Phillips y Planos

Descripción	Referencia	U/E
Juego de 8 Destornilladores de Precision Phillips y Planos	0880 32108MR	1

Composición:

- Destornillador Plano 1.5 x 40
- Destornillador Plano 2.0 x 40
- Destornillador Plano 2.5 x 40
- Destornillador Plano 3.0 x 40
- ⊕ Destornillador Philips PH000 x 40
- ⊕ Destornillador Philips PH00 x 40
- ⊕ Destornillador Philips PH0 x 40
- ⊕ Destornillador Philips PH1 x 40

- Varilla redonda de acero SNCM+V, cabeza tratada.
- Empuñadura de PP (polipropileno).
- Sección rotativa en la punta del destornillador.
- Acabado cromado pulido.



Destornillador Plano (DIN 5264-A)

Descripción	Referencia	U/E
Destornillador plano 0,8x4,5. Longitud total 188mm	0833 325 045	1
Destornillador plano 1,0x5,5. Longitud total 205mm	0833 325 055	1
Destornillador plano 1,2x7. Longitud total 230mm	0833 325 070	1
Destornillador plano 1,6x9. Longitud total 262mm	0833 325 090	1
Destornillador plano 1,6x10. Longitud total 287mm	0833 325 100	1
Destornillador plano 2,0x12. Longitud total 317mm	0833 325 120	1
Destornillador plano 2,5x14. Longitud total 367mm	0833 325 140	1

- Mango bicomponente, una parte dura resistente y otra blanda que le aporta ergonomía.
- Mango antideslizante.
- Punta endurecida.
- Acero cromo-vanadio en la varilla, varilla hexagonal para poder realizar aprietes con llave fija.
- Placa de golpe en la parte superior del mango.



Destornillador Philips (DIN 5260-PH)

Descripción	Referencia	U/E
Destornillador PH1. Longitud total 178mm	0833 326 001	1
Destornillador PH2. Longitud total 205mm	0833 326 002	1
Destornillador PH3. Longitud total 262mm	0833 326 003	1
Destornillador PH4. Longitud total 317mm	0833 326 004	1

- Mango bicomponente, una parte dura resistente y otra blanda que le aporta ergonomía.
- Mango antideslizante.
- Punta endurecida.
- Acero cromo-vanadio en la varilla, varilla hexagonal para poder realizar aprietes con llave fija.
- Placa de golpe en la parte superior del mango.





Conjunto de Destornilladores (para tornillos ranurados y philips)

Descripción	Referencia	U/E
4 destornilladores planos y 2 destornilladores philips	0833 324 005	1 (6 uds.)

- Conjunto de 6 destornilladores, suministrados en soporte especial:
 - o 1 plano 0,6x3,5. Longitud total 161mm.
 - o 1 plano 0,8x4,5. Longitud total 188mm.
 - o 1 plano 1,0x5,5. Longitud total 205mm.
 - o 1 plano 1,2x7,0. Longitud total 230mm.
 - o 1 PH1 Longitud total 178mm.
 - o 1 PH2 Longitud total 205mm.



Destornillador Torx

Descripción	Referencia	U/E
Destornillador TX 15. Longitud total 178mm	0833 328 015	1
Destornillador TX 20. Longitud total 198mm	0833 328 020	1
Destornillador TX 25. Longitud total 205mm	0833 328 025	1
Destornillador TX 30. Longitud total 220mm	0833 328 030	1
Destornillador TX 40. Longitud total 242mm	0833 328 040	1

- Mango bicomponente, una parte dura resistente y otra blanda que le aporta ergonomía.
- Mango antideslizante.
- Acero cromo-vanadio en la varilla, hexagono en la parte superior de la varilla para poder realizar aprietes con llave fija.
- Punta endurecida. o 1 PH2 Longitud total 205mm.



Conjunto Destornilladores Torx (para tornillos torx)

Descripción	Referencia	U/E
TX 10-15-20-25-30-40	0833 327 005	1 (6 uds.)

- Conjunto de 6 destornilladores, suministrados en soporte especial:
 - o 1 TX10. Longitud total 161mm.
 - o 1 TX15. Longitud total 178mm.
 - o 1 TX20. Longitud total 198mm.
 - o 1 TX25. Longitud total 205mm.
 - o 1 TX30. Longitud total 220mm.
 - o 1 TX40. Longitud total 242mm.





Destornillador Flexible para Abrazaderas

Descripción	Referencia	U/E
Destornillador flexible SW6	0833 330 006	1
Destornillador flexible SW7	0833 330 007	1
Destornillador flexible SW8	0833 330 008	1

- Largo varilla: 167 mm.
- Largo empuñadura: 98 mm.
- Largo total: 265 mm.



Destornillador Torx Inviolable

Descripción	Referencia	U/E
Destornillador TX 15 inviolable. Longitud total 178mm	0833 327 015	1
Destornillador TX 20 inviolable. Longitud total 198mm	0833 327 020	1
Destornillador TX 25 inviolable. Longitud total 205mm	0833 327 025	1

- Mango bicomponente, una parte dura resistente y otra blanda que le aporta ergonomía.
- Mango antideslizante.
- Acero cromo-vanadio en la varilla, varilla redonda y punta endurecida.



Conjunto de Varillas Reversibles (Juego de 11 piezas)

Descripción	Referencia	U/E
TX 10-15-20-25-30-40	0833 331 005	1 (11 uds.)

- Conjunto de 11 Varillas Reversibles:
 - o 1 mango de varilla reversible,
 - o 4 varillas planas,
 - o 3 varillas SW,
 - o 2 varillas PH,
 - o 2 varillas PZ,
 - o 4 varillas TX.





Mango de Varillas Reversibles

Descripción	Referencia	U/E
Mango de varillas reversibles para varillas de 6 mm	0833 331 010	1



Despiece del Conjunto de Varillas, Ø 6 mm

Descripción	Referencia	U/E
Varillas reversible plana 40x60	0833 331 406	1
Varillas reversible plana 50x70	0833 331 507	1
Varillas reversible Hx4	0833 331 104	1
Varillas reversible Hx5	0833 331 105	1
Varillas reversible Hx6	0833 331 106	1
Varillas reversible PH1/PH2	0833 331 012	1
Varillas reversible PZ1/PZ2	0833 331 102	1
Varillas reversible TX10/TX15	0833 331 015	1
Varillas reversible TX20/TX25	0833 331 025	1
Varillas reversible TX30/TX40	0833 331 040	1
Varillas combinada PH1/Plana 4 mm	0833 331 401	1
Varillas combinada PH2/Plana 6 mm	0833 331 602	1



Magnetizador Desmagnetizador para Destornilladores

Descripción	Referencia	U/E
Magnetizador desmagnetizador para destornilladores	0850 550 112	1





Juego Torx Invi 5 Alas Extralargo

Descripción	Referencia	U/E
Juego de 9 llaves torx invi 5 alas extralargas	0850 020 247	1



Destornillador Extralargo Torx

Descripción	Referencia	U/E
Destornillador extralargo torx TX20x300	0833 528 070	1
Destornillador extralargo torx TX25x300	0833 528 071	1
Destornillador extralargo torx TX30x300	0833 528 073	1



Imán Flexible

Descripción	Referencia	U/E
Imán flexible de 200 gr.	0833 153 1	1
Imán flexible de 2,5 kg.	0850 550 025	1





Juego de 13 Vasos 1/2 de Impacto, Multicara

Descripción	Referencia	U/E
Juego de 13 vasos 1/2 de impacto multicara	0850 515 090	1 (13 uds.)

- Contenido: 1 vaso de 10 mm; 1 vaso de 12 mm; 1 vaso de 13 mm; 1 vaso de 14 mm; 1 vaso de 15 mm; 1 vaso de 16 mm; 1 vaso de 17 mm; 1 vaso de 19 mm; 1 vaso de 20 mm; 1 vaso de 21 mm; 1 vaso de 22 mm; 1 vaso de 23 mm y 1 vaso de 24 mm.



Vaso 1/2 Punta xzn Inviolable (Caja de cambios Audi)

Descripción	Referencia	U/E
Vaso 1/2 con punta xzn inviolable 55 mm	0840 805 516	1
Vaso 1/2 con punta xzn inviolable 100 mm	0840 080 517	1



Conjunto de Carraca de 1/4", 46 piezas

Descripción	Referencia	U/E
Conjunto de carraca de 1/4"	0850 151 138	1 (46 uds.)

Descripción	Unids.	Dimensiones
○ Llaves de vaso hexagonales	13	4-4-5-5-5-5-6-7-8-9-10-11-12-13-14mm
⊛ Llaves de vaso Torx	6	T10-T15-T20-T25-T30-T40
● Vasos punta hexagonal	6	3-4-5-6-7-8 mm
◐ Vasos punta plana	3	4-5,5-7
⊕ Vasos punta Phillips	3	PH1-PH2-PH3
⊕ Vasos punta Pozidriv	3	PZ1-PZ2-PZ3
Mango corredizo	1	L-115mm
Articulación universal	1	90°
Alargadera	2	L-50mm / L-100mm
Alargadera flexible	1	L-150mm
Llaves allen	4	1,5-2-2,5-3
Mango cuadrado macho 1/4"	1	L-150mm
Carraca	1	72 dientes



Carraca de 1/4" Mango Giratorio

Descripción	Referencia	U/E
1 Carraca	0850 100 105	1

- Carraca con vástago reversible.
- Girando el mango transmitimos el giro al cuadratillo 1/4.





Juego Completo 1/4 y 1/2, 108 piezas

Descripción	Referencia	U/E
Juego Completo 1/4 y 1/2, 108 piezas	0833 510 005	1 (108 uds.)

Descripción	Unids.	Dimensiones
Liaves de vaso hexagonales 1/2"	17	10-11-12-13-14-15-16-17-18-19-20-21-22-23-27-30-32 mm
Liaves de vaso hexagonales 1/4"	13	4-4.5-5-5.5-6-7-8-9-10-11-12-13-14 mm
Liaves de vaso hexagonales largas 1/2"	5	14-15-17-19-22 mm
Liaves de vaso hexagonales largas 1/4"	8	6-7-8-9-10-11-12-13 mm
Liaves de vaso hexagonales largas	2	16-21 mm bujías 1/2"
Liaves de vaso Torx 1/2"	8	E-10, E-11, E-12, E-14, E-16, E-18, E-20, E-24
Liaves de vaso Torx 1/4"	5	E-4, E-5, E-6, E-7, E-8
Vasos punta plana 1/4"	3	0.75x4 - 1x5.5 - 1.25x6.5 mm
Vasos punta Phillips 1/4"	2	PH 1 - PH 2
Vasos punta Pozidriv 1/4"	2	PZ 1 - PZ 2
Vasos punta hexagonal 1/4"	4	3-4-5-6 mm
Vasos punta Torx 1/4"	7	T-8, T-10, T-15, T-20, T-25, T-27, T-30
Punta plana 5/16"	3	1x8 - 1.5x10 - 1.75x12
Punta Phillips 5/16"	2	PH 3 - PH 4
Punta Pozidriv 5/16"	2	PZ 3 - PZ 4
Punta hexagonal 5/16"	5	7-8-10-12-14 mm
Punta Torx 5/16"	5	T-40, T-45, T-50, T-55, T-60
Adaptador	1	1/2" a 5/16"
Liaves Allen	3	1.5 - 2 - 2.5 mm
Mango corredizo 1/4"	1	L=250 mm
Articulación universal	2	1/4"-1/2" 90°
Amplificador Convertidor de Alargadera de 1/2" en mango corredizo	1	3/8" a 1/2"
Alargadera 1/4" a 1/2"	4	L=50; L=100mm/L=125; L=250 mm
Mango cuadrado macho 1/4"	1	L=150 mm
Carraca 1/4" a 1/2"	2	24 Dientes



Despieces no representados en las páginas siguientes, consultar lista de precios o consultar al departamento de productos.



Estuche Herramientas, 216 piezas

Descripción	Referencia	U/E
Estuche Herramientas de 216 piezas	0833 984 030	1 (216 uds.)



Conjunto 42 piezas, Culata

Descripción	Referencia	U/E
Conjunto 42 piezas para culata	0850 911 304	1
Mann. adaptador punta 10 mm. para 1/2	0850 515 008	1
Mann. adaptador punta 10 mm. para 3/8	0850 515 009	1

- Contenido:
 - 7 Hexagonales de 30 mm de: 4, 5, 6, 7, 8, 10 y 12 mm
 - 7 Hexagonales de 75 mm de: 4, 5, 6, 7, 8, 10 y 12 mm
 - 8 Torx de 30 mm de: T20, T25, T30, T40, T45, T50, T55, T60
 - 8 Torx de 75 mm de: T20, T25, T30, T40, T45, T50, T55, T60
 - 5 Spline de 30 mm de: M5, M6, M8, M10 y M12
 - 5 Spline de 75 mm de: M5, M6, M8, M10 y M12
 - 1 Adaptor de 1/2" x 10 mm,
 - 1 Adaptor de 3/8" x 10 mm





Conjunto Puntas Ribe 14 piezas

Descripción	Referencia	U/E
Conjunto 14 piezas para culata	0850 911 306	1 (14 uds.)
Mann. adaptador punta 10 mm. para 1/2	0850 515 008	
Mann. adaptador punta 10 mm. para 3/8	0850 515 009	

- Surtido completo de puntas para reparaciones en zonas de motor.
- Las puntas RIBE están especialmente indicadas para reparaciones de vehículos del grupo VAG, grupo FIAT, y en motores de vehículos japoneses.
- Son utilizadas en las reparaciones de montaje y desmontaje de culata, poleas de correas de distribución, tapa de balancines, soportes de motor, etc.



Puntas Ribe 5/16 de 38 mm largo

Medida	Referencia	U/E
ribe M5 5/16	0850 911 165	1
ribe M6 5/16	0850 911 166	1
ribe M7 5/16	0850 911 167	1
ribe M8 5/16	0850 911 168	1
ribe M10 5/16	0850 911 169	1
ribe M12 5/16	0850 911 170	1



Puntas Ribe 5/16 de 100 mm largo

Medida	Referencia	U/E
ribe M7 5/16	0850 911 171	1
ribe M8 5/16	0850 911 172	1
ribe M9 5/16	0850 911 173	1
ribe M10 5/16	0850 911 174	1
ribe M12 5/16	0850 911 175	1
ribe M13 5/16	0850 911 176	1
ribe M14 5/16	0850 911 177	1





Juego de vasos reforzados antirrobo, 16 vasos

Descripción	Referencia	U/E
Juego de vasos reforzados antirrobo	0840 764 305	1 (16 uds.)



Alicates Pico de Loro Cobra

Descripción	Referencia	U/E
Alicates pico de loro cobra de 250 mm	0833 318 300	1

- Tenaza de apriete especial, con once posiciones de ajuste.
- Mango bicomponente antideslizante, ergonómico.
- Fabricada en acero cromo-vanadio.



Tijeras para Cortar Chapa

Descripción	Referencia	U/E
Tijeras para cortar chapa, corte a izquierdas	0850 118 053	1
Tijeras para cortar chapa, corte a derechas	0850 118 052	1

- Tijera para cortar chapa de corte a izquierdas.
- Tijera para cortar chapa de corte a derechas.



Alicate de Sirga para Abrazaderas

Descripción	Referencia	U/E
Alicate de Sirga para Abrazaderas Elásticas	0850 309 104	1

- Alicata con cierre para dejar retenida la abrazadera mientras se trabaja. Medidas 18-54.





Mordazas Grip

Descripción	Referencia	U/E
Mordazas grip	0850 115 084	1

- Mordaza de apriete rápido.
- Fabricadas en acero cromo-vanadio con acabado niquelado brillante.



Mordazas Grip

Descripción	Referencia	U/E
Mordazas grip	0850 115 080	1

- Mordaza de apriete rápido.
- Fabricadas en acero cromo-vanadio con acabado niquelado brillante.



Mordazas Grip

Descripción	Referencia	U/E
Mordazas grip	0850 115 081	1

- Mordaza de apriete rápido.
- Fabricadas en acero cromo-vanadio con acabado niquelado brillante.



Mordazas Grip

Descripción	Referencia	U/E
Mordazas grip	0850 115 082	1

- Mordaza de apriete rápido.
- Fabricadas en acero cromo-vanadio con acabado niquelado brillante.





Mordazas Microgrip 2000

Descripción	Referencia	U/E
Mordazas microgrip 2000 de empuñadura vertical	0834 200 040	1

- Fácil manejo debido a su pequeño tamaño, 92mm.
- Ideal para sujeciones con acceso reducido.
- Está fabricada con un tratamiento térmico de aleación de aluminio resistente a salpicaduras de soldadura.
- No corrosiva. Ligera.
- Sólido tornillo de latón ajustable.
- La línea recta de movimiento hace posible que la mandíbula móvil permita un sujeción vertical en espacios reducidos.



Cepillo de Alambre Acero Inoxidable para Mecánicos

Descripción	Referencia	U/E
Cepillo de acero inoxidable para mecánicos	0850 201 301	1



Cepillo Latonado para Mecánicos

Descripción	Referencia	U/E
Cepillo latonado para limpiezas de pinzas de freno de aluminio	0850 201 302	1



Cepillo de Alambre para Chapistas

Descripción	Referencia	U/E
Cepillo de alambre para chapistas	0840 300 139	1





Cepillo de Mecánico

Descripción	Referencia	U/E
Cepillo para limpiar bujías	0833 741 601	1



Extractor de Filtros de Aceite

Descripción	Referencia	U/E
Extrac. filtros de aceite 3 garras de 72 a 127 mm	0870 014930077	1
Extrac. filtros de aceite 3 garras de 95 a 165 mm	0833 300 1	1



Ref. 0870 014930077

Ref. 0833 300 1

Extractor Filtros de Aceite de Garras Planas

Descripción	Referencia	U/E
Extractor filtros de aceite de garras planas	0833 051 530	1





Set de 30 Cazoletas para Extraer Filtros de Aceite

Descripción	Referencia	U/E
Set de 30 cazoletas para extraer filtros de aceite	0850 509 350	1

- COMPOSICIÓN:
Medidas: 1 llave filtro 3 garras, 1 adaptador 3/8" x 1/2".
066 / 6Fiat Punto 1.2, Renault Clio 1.2, Twingo.
065 / 14Daihatsu, Toyota, Nissan, Fiat.
066 / 67Daihatsu, Toyota.
068 / 14Mazda, Ford, Subaru.
073 / 14Toyota, Lexus.
074 / 15Audi, Rover, Chrisler.
074 / 76Ford, Opel, VW, Audi, Mercedes.
075 / 77VW, Audi, Isuzu, Mercedes.
076 / 12Fiat, Mercedes, Renault.
076 / 30Ford.
076 / 8Fiat, Lancia.
078 / 15Nissan, Ford, Toyota.
080 / 15Nissan, Honda, Opel, Mazda.
080 / 82Subaru, Toyota, Honda, Nissan.
086 / 16Volvo.
086 / 18VW Golf, Audi A6 TDi, Peugeot, Citroën.
090 / 15Honda, Mitsubishi, Isuzu.
092 / 10Fiat.
093 / 15Mazda, Volvo, Mitsubishi, Isuzu.
093 / 36Ford.
093 / 45VW, Audi TDi.
095 / 15Toyota, Alfa - Romeo, Ford.
096 / 18Audi A4, A6 Tdi, VW Passat TDi, Renault Laguna.
100 / 15Isuzu, Mitsubishi.
106 / 15Fiat Ducato.
108 / 15Volvo.
108 / 18Renault Espace, Laguna, Safrane, Traffic.
- **Para la reposición de cualquier cazoleta es importante saber la medida de el diámetro y la altura. CONSULTAR.**



Llave Filtros de Aceite Automática USAG

Descripción	Referencia	U/E
Llave Filtros de Aceite Automática USAG	0833 443 005	1

- Regulación Automática de la cinta.
- Mordaza articulada para amarre del filtro y efecto carraca.
- Mango de material plástico de alta resistencia de 160 mm de longitud.
- Cinta de acero inoxidable.
- Capacidad: Ø 66-105mm.



Extractor de Brazo Limpia Parabrisas

Descripción	Referencia	U/E
Extractor de brazo limpia parabrisas	0833 570 1	1

- Extractor para brazo limpia parabrisas formado por cuerpo y dos patas finas, lo que facilita la extracción del brazo sin dañar componentes de la carrocería.
- Cuatro posiciones de apertura de pata, girando el cuerpo y las patas de diferente anchura se consiguen las diferentes aperturas.
- Fabricado en acero para herramientas de gran resistencia.





Extractor de 2 Patas

A	B	PESO	Referencia	U/E
55	70	0,2	0833 130 0	1
85	100	0,4	0833 130 1	1
135	150	1,2	0833 130 4	1
180	200	2,3	0833 130 7	1
300	310	5,5	0833 131 0	1
365	425	11,5	0833 131 7	1



Extractor de 3 Patas

A	B	PESO	Combina 2/3 patas	Referencia	U/E
55	70	0,3	NO	0833 130 00	1
85	100	0,7	SI	0833 130 10	1
135	150	1,8	SI	0833 130 40	1
180	200	3,3	SI	0833 130 70	1
300	310	7,5	SI	0833 131 00	1
365	425	16,5	NO	0833 131 70	1



Guillotinas

B	A máx.	A mín.	PESO	Ø	Referencia	U/E
60	55	4	0,75	3/8"	0833 120 2	1
80	80	5	1,3	3/8"	0833 120 3	1
110	110	10	2,75	5/8"	0833 120 4	1
152	134	11	5,7	5/8"	0833 120 6	1
180	210	13	12,5	5/8"	0833 120 8	1



COMBINACIONES

Referencia alargadera	Referencia guillotina
0833 110 2	0833 120 2
0833 110 3	0833 120 3
0833 111 0	0833 120 4
0833 112 0	0833 120 6
0833 112 5	0833 120 8

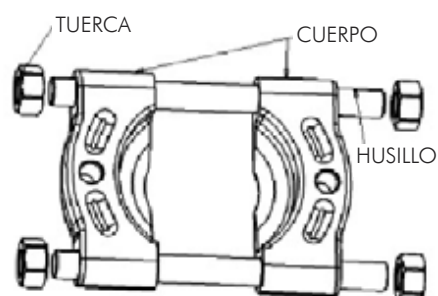



Alargadera Extractor Mecánico

A	B máx.	B mín.	PESO	Referencia	U/E
115	110	46	1,0	0833 110 2	1
115	140	46	1,0	0833 110 3	1
175	195	62	3,0	0833 111 0	1
245	325	105	9,5	0833 112 0	1
245	445	173	12,0	0833 112 5	1

COMBINACIONES

Referencia alargadera	Referencia guillotina
0833 110 2	0833 120 2
0833 110 3	0833 120 3
0833 111 0	0833 120 4
0833 112 0	0833 120 6
0833 112 5	0833 120 8

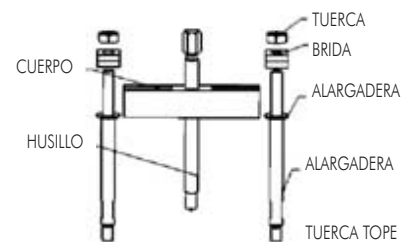
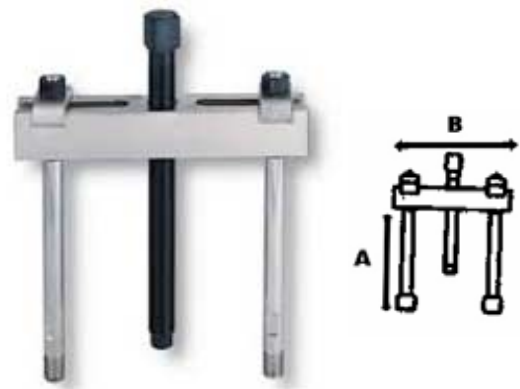

Extractor de 2 Patas Oscilante

A	B máx.	B mín.	PESO	Referencia	U/E
80	80	15	1	0833 100 2	1
80	125	15	1,1	0833 100 3	1
135	125	15	1,3	0833 100 30	1
160	150	25	2,4	0833 101 0	1
220	145	25	4	0833 101 00	1
220	195	60	3,6	0833 101 5	1

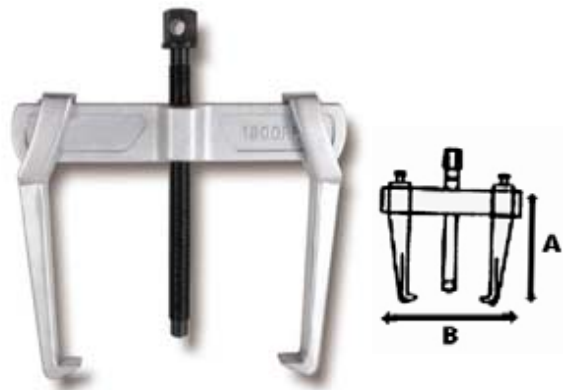

Extractor de Rótulas

∅	altura	posiciones	Referencia	U/E
20 a 24	36	2	0833 569 1	1





Calibre Manual

Descripción	Referencia	U/E
Calibre de 0 a 150 mm	0850 300 510	1



Calibre Digital

Descripción	Referencia	U/E
Calibre de 0 a 150 mm	0850 300 520	1



Micrómetro

Descripción	Referencia	U/E
Micrómetro de 0 a 25 mm	0845 617 698	1



Juego de Galgas Rosca Métrica

Descripción	Referencia	U/E
Juego de galgas rosca métrica	0840 635 486	1



Flexómetro Metálico

Descripción	Referencia	U/E
Flexómetro magnético metálico de 5 x 19 mm	0841 610 67	1





Cutter de 18 mm

Descripción	Referencia	U/E
Cutter ancho 18 mm	0850 309 106	1
Recambio cutter ancho 18 mm	0850 309 304	1 (10 uds.)



Cutter de 9 mm

Descripción	Referencia	U/E
Cutter ancho 9 mm	0850 907 152	1
Recambio cutter ancho 9 mm	0850 907 168	1 (10 uds.)



Cutter de Tapicero

Descripción	Referencia	U/E
Cutter de tapicero	0850 907 170	1
Set cuchillas trapezoidales	0840 382 191	1 (10 uds.)



Cutter Corta Lunas

Descripción	Referencia	U/E
Cutter corta lunas	0850 140 241	1
Recambio del cutter 1 pieza	0840 358 131	1





Rollo de Cable de Corte Cuadrado

Descripción	Referencia	U/E
Rollo cable cuadrado 44 m	0850 309 301	1

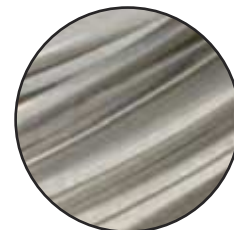

Rollo de Cable de Corte Trenzado

Descripción	Referencia	U/E
Rollo cable trenzado 20 m	0850 140 211	1

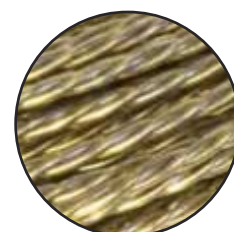

Juego de Mangos de Estirar

Descripción	Referencia	U/E
Juego mangos para tirar del alambre de corte de lunas	0850 140 210	1



Mango de Sujetar

Descripción	Referencia	U/E
Mango para fijar el alambre de corte de lunas	0850 140 205	1



Lezna Introdutora de Alambre de Lunas

Descripción	Referencia	U/E
Lezna introductora de alambre de lunas	0850 140 226	1
Sonda para alambre de 2,5 mm	0833 309 312	1

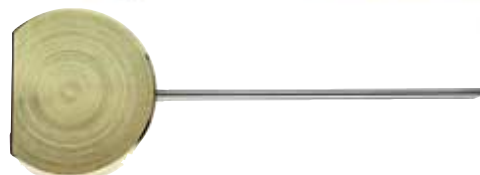



Set de 4 Espátulas Metálicas

Descripción	Referencia	U/E
Set de 4 espátulas metálicas	0850 907 210	1

- Espátulas con cuchilla de acero inoxidable y mango bicomponente antideslizante.
- Para trabajos de chapa mecánica e industria.



Ventosa Individual

Descripción	Referencia	U/E
Ventosa Individual	0850 309 305	1



Kit de Ventosas Dobles con Tensor

Descripción	Referencia	U/E
Kit de ventosas dobles con tensor	0850 309 306	1
Unidad de ventosa doble	0850 309 307	1



Juego Completo de Cuters

Descripción	Referencia	U/E
Juego completo de cuters	0840 382 514	1
Set 5 cuchillas 12 mm ancho	0840 382 102	1 (5 uds.)
Set 5 cuchillas 16 mm ancho	0840 382 103	1 (5 uds.)
Set 5 cuchillas 16 mm ancho 53°	0840 382 104	1 (5 uds.)
Set 5 cuchillas 20 mm ancho	0840 382 105	1 (5 uds.)
Set 5 cuchillas trapezoidales	0840 382 191	1 (5 uds.)





Sacagrapas Recto

Descripción	Referencia	U/E
Sacagrapas recto 230 mm	0845 619 269	1



Sacagrapas de Palanca

Descripción	Referencia	U/E
Sacagrapas de palanca 230 mm	0845 619 267	1



Alicate Sacagrapas de Tijera

Descripción	Referencia	U/E
Alicate sacagrapas de tijera	0850 320 005	1



Alicate para Grapas de Tapizado

Descripción	Referencia	U/E
Alicate para Grapas de Tapizado	0840 012 110	1



Grapas para Tapicería de Asiento

Descripción	Referencia	U/E
Grapas para Tapicería de asiento (100 Uds.)	0840 500 008	1





Kit Extractor Pasadores de Puertas

Descripción	Referencia	U/E
1 extractor más 4 pasadores	0840 300 150	1



Juego Útiles Nylon para tapizados 27 piezas

Descripción	Referencia	U/E
Juego Útiles Nylon para desmontar tapizados 27 piezas	0840 525 027	1



Lima plana abolladuras

Descripción	Referencia	U/E
Lima plana abolladuras, largo 360 mm, ancho 35 mm, grueso 7,3 mm	0833 059 400	1

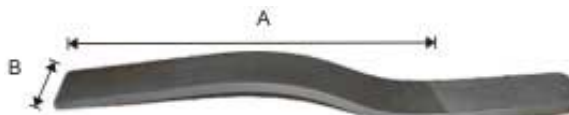

Arco de Lima

Descripción	Referencia	U/E
Arco de lima con hoja de grano grueso incluida	0833 300 120	1



Limas de Chapista

Descripción	Referencia	U/E
Repuestos de lima, radial, grano fino	0833 300 121	1
Repuestos de lima, radial, grano medio	0833 300 122	1
Repuestos de lima, radial, grano grueso	0833 300 123	1
Repuestos de lima, sesgada, grano medio	0833 060 012	1
Repuestos de lima, sesgada, grano grueso	0833 060 013	1
Repuestos de lima, SEMIRREDONDA, grano grueso	0833 060 014	1





Panel Bag (Bolsa Neumática)

Descripción	Referencia	U/E
Panel bag (bolsa neumática)	0850 116 103	1

- Bolsa de aire duradera con perfiles rígidos y resistentes.
- Ideal para colocar paneles de puerta y capós.
- Medidas 150 x 200 mm.



Ventosas con Cable

Descripción	Referencia	U/E
Ventosas con cable	0850 140 106	1

- Sujeta los lados de la ventanilla durante el cambio de elevelunas, cristal, etc.
- Previene deslizamientos del cristal y evita usar otras herramientas que pueden dañar la tapicería o romper el cristal.



Kit Rasquetas de Gubia y Plana

Descripción	Referencia	U/E
Rasqueta plana 12,5mm x 200mm	0850 907 231	1
Rasqueta plana 25mm x 200mm	0850 907 232	1



Remachadora Combinada 3 en 1

Descripción	Referencia	U/E
Remachadora Combinada 3 en 1	0850 819 500	1

- Combinada 3 en 1 para uso profesional.
- Capacidad: remaches 3,2; 4; 4,8 y 6,4. y ciegos M4/5/6/8 y 12 y tuercas remachables M4, M5, M6 y M8.
- Se suministra en maletín PVC.



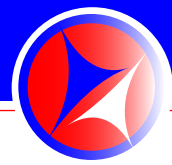

Remachadora Manual

Descripción	Referencia	U/E
Remachadora manual	0833 309 202	1

- Remachadora manual: peso 0,70 kg, longitud 255 mm, para boquillas de diámetro 3,0-5,0.



Remachadora de Palanca Larga, 52 cm

Descripción	Referencia	U/E
Remachadora de palanca	0833 309 203	1
Boquilla p/remaches 3,2	0833 309 231	1
Boquilla p/remaches 4	0833 309 232	1
Boquilla p/remaches 4,8	0833 309 233	1
Boquilla p/remaches 6	0833 309 234	1
Boquilla p/remaches 6,4	0833 309 235	1

- Remachadora de palanca: peso 1.800 kg, longitud 500 mm, para boquillas de diámetro 3,2 - 6,4.





Remachadora de Tuercas de Palanca

Descripción	Referencia	U/E
Remachadora de tuercas de palanca	0833 309 205	1
Mandril M5 (MFX 510 QI)	0833 309 251	1
Mandril M6 (MFX 510 QI)	0833 309 252	1
Mandril M8 (MFX 510 QI)	0833 309 253	1
Mandril M10 (MFX 510 QI)	0833 309 254	1

- Remachadora de tuercas manual: peso 1,8 kg, longitud 440 mm, para tuercas remachables M4, M5, M6 y M8.



Remachadora para Remaches de Plástico

Descripción	Referencia	U/E
Remachadora	0840 540 001	1
Remache de Ø 6,3x25,2 mm	0840 586 325	50/100
Remache de Ø 5x17,2 mm	0840 585 172	50/100
Remache de Ø 6,6x17,3 mm	0840 586 617	50/100

Remaches de Plástico



Descripción	Ø	L	Ø _{ALA}	Referencia	U/E
Remache Plástico	5	17,2	12,5	0840 585 172	50/100
Remache Plástico	6,3	25,2	17	0840 586 325	50/100
Remache Plástico	6,6	17,3	17,5	0840 586 617	50/100





Tases para Chapista

Descripción	Referencia	U/E
Tas cuña alomado, A-116mm, B-61mm, grosor 26mm	0860 037	1
Tas diábolo, A-65mm, B-55mm, C-65mm, 1.000g	0860 038	1
Tas aleta, A-150mm, B-30mm, C-60mm, 1.000g	0860 039	1
Tas de coma cara superior abombada, A-130mm, B-55mm, C-20mm, 1.530g	0860 774	1
Tas dactilado cara plana lisa y cara curva fresada, A-120mm, B-57mm, grosor 25mm, 1.130g	0860 773	1
Tas dactilado fino cara plana y cara curvada, A-115mm, B-55mm, grosor 25mm, 1.000g	0860 775	1
Tas dactilado fino cara plana y cara curvada, A-120mm, B-55mm, grosor 30mm, 1.360g	0860 776	1

- **OTROS TASES CONSULTAR.**



Extractor Desabollador a Golpe

Descripción	Referencia	U/E
Extractor desabollador a golpe, peso 4.300 gramos	0860 332	1





Palancas para Chapista

Descripción	Referencia	U/E
Palanca pesada caras curvas, A-300mm, B-65mm, C-170mm, D-60 mm, peso 1.800g	0860 167	1
Palanca dos caras doble curva, A-250mm, B-150mm, ancho de pala 50mm, peso 1.450g	0860 058	1
Palanca ligera cara recta, A-170mm, B-25mm, peso 600 gramos	0860 163	1
Trancho cara curva con el canto redondeado, A-120mm, B-270, peso 950g	0860 673	1

- **OTRAS PALANCAS CONSULTAR.**

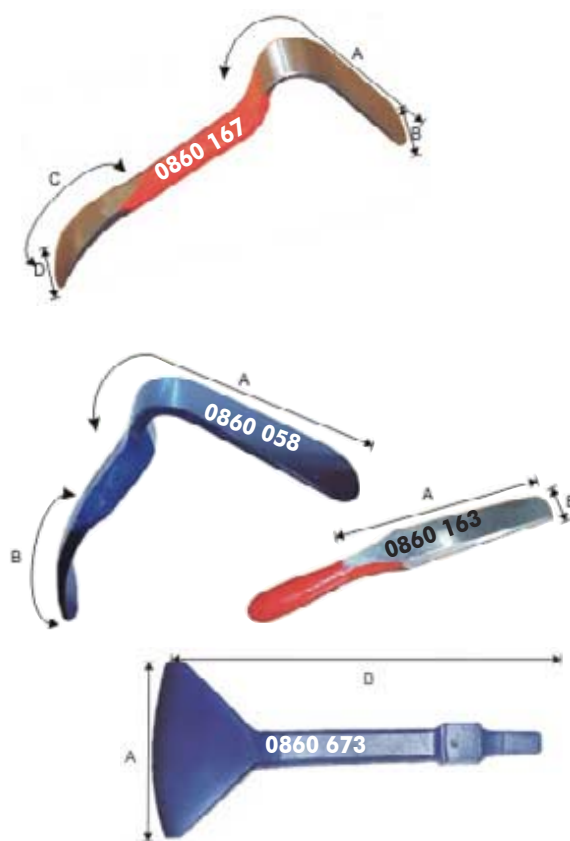



Pistola Manual Universal

Descripción	Referencia	U/E
Pistola manual universal 310/400 ml	0901 128 8	1
Pistola manual universal 600 ml	0901 179 9	1

- Pistola para la extrusión de diferentes selladores, para cartucho y bolsas de diferentes medidas.
- Pistola robusta y resistente para ser utilizada en talleres de chapa, talleres de lunas, etc.



Pistola Neumática IR

Descripción	Referencia	U/E
Pistola neumática IR 310 ml LA428-EU	0880 SK1010	1

- Pistola de accionamiento neumático a través del aire de la instalación del taller.



Pistola Neumática Universal

Descripción	Referencia	U/E
Pistola neumática universal para cartucho 310ml	0901 127 6	1
Pistola neumática universal bolsa 400 ml	0901 121 070	1
Pistola neumática universal bolsa 600 ml	0901 212 2	1
Repuesto regulador de presión de aire	0901 121 074	1

- Pistola de accionamiento neumático a través del aire de la instalación del taller.
- Pistola para la extrusión de diferentes selladores, para cartucho y bolsas de diferentes medidas.
- Pistola robusta y resistente para ser utilizada en talleres de chapa, talleres de lunas, etc.





Pistola Neumática Polímero Pulverizable P/Cartucho 300ml

Descripción	Referencia	U/E
Pistola Neumática Polímero Pulverizable	0901 000 018	1
Cánula Pegamento Lunas Larga (B)	0902 457 100	10
Cánula de Mariposa/Polímero MS, 3 en 1 Pulverizable (C)	0902 457 134	10
Cánula de Cordón/Polímero MS, 3 en 1 Pulverizable (D)	0902 457 136	10



- Pistola de accionamiento neumático a través del aire de la instalación del taller.
- Pistola profesional para la extrusión y pulverización de selladores mono componentes pulverizables (polímeros MS).
- Gracias a su regulador podemos hacer diferentes tipos de cordones, tanto en forma como en anchos y espesores.
- Dispone de regulador de caudal de aire y de abanico.
- Pistola neumática para cartuchos de 300 ml.
- Cuerpo de latón niquelado forjado de alta calidad
- Presión: trabajar preferentemente entre 3 y 5 bares. Presión máxima admitida 8 bares.
- Consumo de aire: aprox. 200-300 l/minuto.
- Conexión: Conector macho ¼ gas/M14x150.
- Peso: 1,2 kg.
- Boquilla: 1,6-2,5mm.



(B)



(C)



(D)